

# Transmit Diversity and Relay Selection Algorithms for Multirelay Cooperative MIMO Systems

Patrick Clarke, *Student Member, IEEE*, and Rodrigo C. de Lamare, *Senior Member, IEEE*

**Abstract**—In this paper, we propose a set of joint transmit diversity selection (TDS) and relay selection (RS) algorithms based on discrete iterative stochastic optimization for the uplink of cooperative multiple-input–multiple-output (MIMO) systems. Decode-and-forward (DF) and amplify-and-forward (AF) multirelay systems with linear minimum mean square error (MSE), successive interference cancelation, and adaptive reception are considered. The problems of TDS and RS are expressed as MSE and mutual information (MI) joint discrete optimization problems and solved using iterative discrete stochastic algorithms. Such an approach circumvents the need for exhaustive searching and results in a range of procedures with low complexity and increased speed of convergence that can track the optimal selection over an estimated channel. The proposed schemes are analyzed in terms of their complexity, convergence, and diversity benefits and are shown to be both stable and computationally efficient. Their performance is then evaluated via MSE, MI, and bit error rate comparisons and shown to outperform conventional cooperative transmission and, in the majority of scenarios, match that of the optimal exhaustive solution.

**Index Terms**—Cooperative systems, discrete stochastic optimization, minimum mean square error (MMSE) receivers, multiple-input–multiple-output (MIMO) relaying, relay selection (RS), transmit diversity (TD).

## I. INTRODUCTION

COOPERATIVE multiple-input–multiple-output (MIMO) networks have received significant attention in the recent research literature due to their spatial diversity gain, multiplexing gain, robustness, low power, and high capacity. These desirable characteristics make such systems well suited to future mobile network applications where there is a requirement for extended coverage, increased data rates, and enhanced quality of service while minimizing infrastructure investment. Consequently, cooperative MIMO techniques have been incorporated into future mobile protocols [1]–[8]. Although still in their infancy, promising results and techniques for cooperative MIMO systems have been published, predominantly focusing on cooperation protocols, routing, information-theoretic limits, and diversity maximization [2]. The decode-and-forward (DF) and amplify-and-forward (AF) protocols both offer added degrees of freedom, which, when effectively exploited, can lead to

significant performance gains. Cooperative MIMO systems also enable the use of transmit diversity (TD) selection and relay optimization to improve performance and reduce the number of relays burdened with retransmission of the signal. Transmit diversity selection (TDS) and relay selection (RS) can be viewed as suboptimal variants of beamforming, where transmit powers are constrained to discrete values of 1 and 0. However, a trade-off exists between this suboptimality and the reduced feedback requirements resulting from the 1-bit quantization [9], [10]. The multiplexing gain resulting from MIMO systems is an attractive feature, but there is an associated increase in interference from multistream transmission. When channel state information (CSI) is available at the receiver, this interference can be mitigated by the use of successive interference cancelation (SIC) and equivalent techniques, such as the vertical Bell-Labs layered space–time and multibranch implementations [11]–[15]. If CSI is not available, adaptive interference suppression and reception provides an alternative method to mitigate this interference at significantly lower computational expense [18]–[21]. Previous works [22]–[29] that have addressed antenna selection and RS considered various approaches to obtain increased performance and low complexity. A number of works dealing with antenna selection have been reported in [22]–[25], where the criteria ranged from the minimum mean square error (MMSE) [22] to the maximum signal-to-noise ratio [23], [24] and the sum rate [25]. Techniques for cooperative interference suppression have been reported in [26]–[28].

In this paper, the problem of low-complexity optimization of TDS with the aid of RS is addressed for a cooperative MIMO system, where a variety of MMSE-based reception techniques are used. The finite nature of TDS makes it a discrete optimization problem where conventional continuous iterative methods are unsuitable. Although solvable with an exhaustive search, this constitutes a highly complex solution and is therefore inappropriate for practical implementation. Consequently, a discrete stochastic method first proposed in [30] is introduced as an alternative low-complexity method to arrive at the optimum TD. However, convergence is dependent upon the size of the set of solutions, and this therefore acts as a limiting factor on the performance of an algorithm. Furthermore, the potential for inaccurate reception at the relays leads to complications and performance implications for the relaying protocol. To address these issues, we introduce a technique termed RS that eliminates the most poorly performing relays from consideration. This leads to a reduction in the cardinality and an increase in the quality of the solution set. To formalize this approach, we develop a joint TDS and RS framework and present a number of discrete iterative algorithms based on the

Manuscript received June 15, 2011; revised November 3, 2011; accepted December 27, 2011. The review of this paper was coordinated by Prof. H. H. Nguyen.

The authors are with the Communications Research Group, Department of Electronics, University of York, YO10 5DD York, U.K. (e-mail: pjc500@ohm.york.ac.uk; rcd1500@ohm.york.ac.uk).

Color versions of one or more of the figures in this paper are available online at <http://ieeexplore.ieee.org>.

Digital Object Identifier 10.1109/TVT.2012.2186619

mean square error (MSE) and mutual information (MI) criteria. These schemes are shown to converge to the exhaustive solution at low computational expense and also operate effectively when recursive least square (RLS) channel estimation is introduced to provide the CSI required for MSE calculation and linear and nonlinear MMSE reception. To illustrate the versatility of the proposed algorithms and their ability to jointly operate with continuous algorithms, they are also applied to low-complexity continuous adaptive interference suppression. We analyze the complexity, convergence, and diversity gains of the proposed algorithms and implement them in a multirelay cooperative MIMO system. Comparisons are drawn against optimal exhaustive solutions, standard cooperative implementations, and the existing greedy antenna selection (GAS) method [22].

The rest of this paper is organized as follows. Section II gives the system and data models, and Section III presents the reception techniques used throughout this paper. Sections IV and V detail the problems that face multirelay cooperative MIMO systems, the corresponding linear and nonlinear MMSE and MI optimization problems, and the framework for their solution. The proposed discrete iterative algorithms that address the optimization problems are given in Section VI. Section VII presents the analysis of and an investigation into the complexity, convergence, diversity, and feedback properties of the proposed algorithms. The performance of the proposed algorithms, along with comparisons against standard cooperative and non-cooperative methods, is then given in Section VIII. This paper is drawn to a close by the concluding remarks given in Section IX.

*Notation:* Throughout this paper, bold upper- and lowercase letters represent matrices and vectors, respectively. The complex conjugate, complex conjugate transpose (Hermitian), inverse, and transpose operations are denoted by  $(\cdot)^*$ ,  $(\cdot)^H$ ,  $(\cdot)^{-1}$ , and  $(\cdot)^T$ , respectively. The trace of a matrix is represented by  $\text{trace}(\cdot)$ , and  $\mathbf{I}_m$  represents an  $m \times m$  identity matrix. Block structures made up of 0s will be represented by  $\mathbf{0}_{M \times D}$ , where  $M$  and  $D$  specify the dimensions of the structure. Estimated values are denoted by the addition of a hat ( $\hat{\cdot}$ ), stacked vectors by the addition of a bar ( $\bar{\cdot}$ ),  $|\cdot|$  represents the cardinality of a set, and  $\text{diag}(\cdot)$  represents a diagonal matrix with the argument's elements across the main diagonal.

## II. SYSTEM AND DATA MODEL

The cooperative network considered in this paper is a two-phase system where the direct path is nonnegligible and no intersymbol interference is assumed. All relays are half-duplex, and MMSE interference suppression and symbol estimation are performed at all decoding nodes. Single source and destination nodes are separated by  $N_r$  intermediate relay nodes, where the channel of each antenna pair is represented by a complex gain. The direct path has a gain that is a fraction of the indirect paths to reflect the increased geographical distance and shadowing involved. The source and destination nodes each have  $N_{as}$  forward and  $N_{ad}$  backward antennas, respectively, and the relay nodes have  $N_{ar}$  forward and backward antennas.  $N_{as}$  data streams are transmitted in the system, and each is allocated to the correspondingly numbered antenna at the source node.

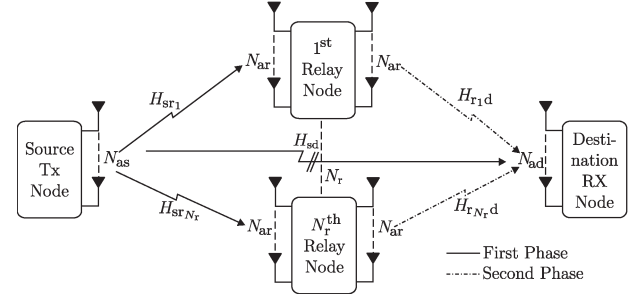

Fig. 1. MIMO multirelay system model.

Data are transmitted in  $N$  symbol packets, and during the first phase, transmission from the source to the relay and destination nodes takes place. The second phase then consists of decoding, power normalization, and forwarding for the DF protocol and a simple power normalization and retransmission for the AF protocol. All channels are assumed uncorrelated, unless otherwise specified, with frequency-flat block fading, where the coherence time is equal to the duration of the  $N$ -symbol packet. The total average transmit power in each phase is maintained at unity and equally distributed between the active antennas. The maximum spatial multiplexing gain and diversity advantage simultaneously available in the system are  $r^* = N_{as}$  and  $d^* = N_{ad}(1 + (N_r N_{ar}/N_{as}))$ , respectively [31], [32]. An outline system model is given in Fig. 1.

### A. Decode-and-Forward

The received signals of the first phase at the destination and  $n$ th relay for the  $i$ th symbol are respectively given by

$$\mathbf{r}_{sd}[i] = \mathbf{H}_{sd}[i] \mathbf{A}_s[i] \mathbf{T}_s[i] \mathbf{s}[i] + \boldsymbol{\eta}_{sd}[i] \quad (1)$$

$$\mathbf{r}_{sr_n}[i] = \mathbf{H}_{sr_n}[i] \mathbf{A}_s[i] \mathbf{T}_s[i] \mathbf{s}[i] + \boldsymbol{\eta}_{sr_n}[i]. \quad (2)$$

The structures  $\mathbf{H}_{sd}$  and  $\mathbf{H}_{sr_n}$  are the  $N_{as} \times N_{ad}$  source–destination and  $N_{as} \times N_{ar}$  source– $n$ th relay channel matrices, respectively. The quantities  $\boldsymbol{\eta}_{sd}$  and  $\boldsymbol{\eta}_{sr_n}$  are the  $N_{ad} \times 1$  and  $N_{ar} \times 1$  vectors of zero mean additive white Gaussian noise at the destination and  $n$ th relay, respectively, whose variances are  $\sigma_{sd}^2$  and  $\sigma_{sr_n}^2$  and autocorrelation matrices  $\sigma_{sd}^2 \mathbf{I}_{N_{ad}}$  and  $\sigma_{sr_n}^2 \mathbf{I}_{N_{sr_n}}$ . The source's  $N_{as} \times 1$  transmit data vector is denoted by  $\mathbf{s}$ , and  $\mathbf{A}_s$  is the diagonal source transmit power allocation matrix that acts to normalize the average total transmit power of the first phase to unity assuming that the modulation scheme is also power normalized to 1. Finally,  $\mathbf{T}_s$  is a diagonal  $N_{as} \times N_{as}$  source TDS matrix, where a 1 on each element of the main diagonal specifies whether the correspondingly numbered antenna is active. Consequently, to maintain the maximum multiplexing gain under the described protocol, all source antennas are required; therefore,  $\mathbf{T}_s[i] = \mathbf{I}_{N_{as}}$  throughout this paper.

At the  $n$ th relay, the output of the reception and interference suppression procedure is denoted  $\mathbf{z}_{r_n}[i]$ , and the decoded symbol vector is given by

$$\hat{\mathbf{s}}_{r_n}[i] = Q(\mathbf{z}_{r_n}[i]) \quad (3)$$

where  $Q(\cdot)$  is a general quadrature-amplitude-modulation slicer.

The  $N_{\text{ad}} \times 1$  second-phase received signal at the destination is the summation of the  $N_r$  relayed signals, yielding

$$\mathbf{r}_{\text{rd}}[i] = \sum_{n=1}^{N_r} \mathbf{H}_{\text{r}_n, \text{d}}[i] \mathbf{A}_{\text{r}_n}[i] \mathbf{T}_{\text{r}_n}[i] \hat{\mathbf{s}}_{\text{r}_n}[i] + \boldsymbol{\eta}_{\text{rd}}[i] \quad (4)$$

where  $\mathbf{H}_{\text{r}_n, \text{d}}$  is the  $n$ th relay–destination channel matrix, and  $\mathbf{A}_{\text{r}_n}[i]$  is the  $n$ th relay transmit power allocation matrix that ensures the total transmit power of the second phase is unity, i.e.,

$$E \left[ \sum_{j=1}^{N_r} \text{trace} \left( \mathbf{A}_{\text{r}_j}^H[i] \mathbf{A}_{\text{r}_j}[i] \right) \right] = 1.$$

$\mathbf{T}_{\text{r}_n}$  is the TDS matrix of the  $n$ th relay that specifies which of its  $N_{\text{ar}}$  antennas are active.

The summation of (4) can be expressed in a more compact form given by

$$\mathbf{r}_{\text{rd}}[i] = \mathcal{H}_{\text{rd}}[i] \mathcal{A}_{\text{r}}[i] \mathcal{T}_r[i] \hat{\mathbf{s}}[i] + \boldsymbol{\eta}_{\text{rd}}[i] \quad (5)$$

where  $\mathcal{T}_r[i] = \text{diag}[\mathbf{T}_{\text{r}_1}[i] \ \mathbf{T}_{\text{r}_2}[i] \ \dots \ \mathbf{T}_{\text{r}_{N_r}}[i]]$  is the  $N_{\text{ar}} N_r \times N_{\text{ar}} N_r$  compound relay TDS matrix,  $\hat{\mathbf{s}}[i] = [\hat{\mathbf{s}}_{\text{r}_1}^T[i] \ \hat{\mathbf{s}}_{\text{r}_2}^T[i] \ \dots \ \hat{\mathbf{s}}_{\text{r}_{N_r}}^T[i]]^T$ ,  $\mathcal{H}_{\text{rd}}[i] = [\mathbf{H}_{\text{r}_1, \text{d}}[i] \ \mathbf{H}_{\text{r}_2, \text{d}}[i] \ \dots \ \mathbf{H}_{\text{r}_{N_r}, \text{d}}[i]]$  is the  $N_{\text{ad}} \times N_{\text{ar}} N_r$  compound channel matrix, and  $\mathcal{A}_{\text{r}}[i] = \text{diag}[\mathbf{A}_{\text{r}_1}[i] \ \mathbf{A}_{\text{r}_2}[i] \ \dots \ \mathbf{A}_{\text{r}_{N_r}}[i]]$  is the compound power allocation matrix, where  $\text{trace}(\mathcal{A}_{\text{r}}^H[i] \mathcal{A}_{\text{r}}[i]) = 1$ . The final received signal at the destination is then formed by stacking the received signals from the relay and source nodes to give

$$\mathbf{r}_d[i] = \begin{bmatrix} \mathbf{r}_{\text{sd}}[i] \\ \mathbf{r}_{\text{rd}}[i] \end{bmatrix}. \quad (6)$$

### B. Amplify-and-Forward

For the AF protocol, the common approach of compounding the first- and second-phase signals and channels is used [10], resulting in the following expressions for the destination's second-phase received signal:

$$\mathbf{r}_{\text{rd}}[i] = \mathcal{H}_{\text{rd}}[i] \mathcal{A}_{\text{r}}[i] \mathcal{T}_r[i] \bar{\mathbf{r}}_{\text{sr}}[i] + \boldsymbol{\eta}_{\text{rd}} \quad (7)$$

where  $\bar{\mathbf{r}}_{\text{sr}}[i] = [\mathbf{r}_{\text{sr}_1}^T[i] \ \mathbf{r}_{\text{sr}_2}^T[i] \ \dots \ \mathbf{r}_{\text{sr}_{N_r}}^T[i]]^T$  can be interpreted as the AF equivalent of  $\hat{\mathbf{s}}[i]$ . Expanding (7) yields

$$\mathbf{r}_{\text{rd}}[i] = \mathcal{H}_{\text{rd}}[i] \mathcal{A}_{\text{r}}[i] \mathcal{T}_r[i] \mathcal{H}_{\text{sr}}[i] \mathbf{A}_{\text{s}}[i] \mathbf{T}_{\text{s}}[i] \mathbf{s}[i] + \mathcal{H}_{\text{rd}}[i] \mathcal{A}_{\text{r}}[i] \mathcal{T}_r[i] \bar{\boldsymbol{\eta}}_{\text{sr}} + \boldsymbol{\eta}_{\text{rd}} \quad (8)$$

where  $\mathcal{H}_{\text{sr}}[i] = [\mathbf{H}_{\text{sr}_1}^T[i] \ \mathbf{H}_{\text{sr}_2}^T[i] \ \dots \ \mathbf{H}_{\text{sr}_{N_r}}^T[i]]^T$ , and  $\mathcal{A}_{\text{r}}[i]$  normalizes the average transmit power of the second phase based on each relay's receive power. The received signals of the first and second phases can then be stacked as in (6) to give  $\mathbf{r}_d[i]$ .

## III. RECEPTION TECHNIQUES

In cooperative MIMO networks, signal detection and interference suppression are required for the signals given by (2) and (6). In this paper, we focus on MMSE-based reception techniques due to their simplicity, versatility, well-understood characteristics, and ease of extracting performance metrics. In

this section, we introduce MMSE techniques that are already known in the literature but whose application to multirelay cooperative MIMO systems is not widespread [18], [22], [32], [33]. However, although beyond the scope of this paper, it is possible to use more complex and sophisticated nonlinear techniques such as decision feedback and maximum likelihood receivers. We primarily concentrate on the DF protocol, but expressions for reception at the destination node are easily transferred to the AF.

### A. Optimal Linear MMSE Reception

Linear MMSE reception can be achieved with the use of the Wiener filter [33]. The cost functions for the Wiener filter at the  $n$ th relay and the destination are given by

$$\mathbf{W}_{\text{r}_n}^{\text{opt}} = \arg \min_{\mathbf{W}_{\text{r}_n}[i]} E \left\| \mathbf{s}[i] - \underbrace{\mathbf{W}_{\text{r}_n}^H[i] \mathbf{r}_{\text{sr}_n}[i]}_{\mathbf{z}_{\text{r}_n}[i]} \right\|^2 \quad (9)$$

$$\mathbf{W}_d^{\text{opt}} = \arg \min_{\mathbf{W}_d[i]} E \left\| \mathbf{s}[i] - \underbrace{\mathbf{W}_d^H[i] \mathbf{r}_d[i]}_{\mathbf{z}_d[i]} \right\|^2 \quad (10)$$

whose dimensions are  $N_{\text{ar}} \times N_{\text{as}}$  and  $2N_{\text{ad}} \times N_{\text{as}}$ , respectively. These expressions yield the following filters:

$$\mathbf{W}_{\text{sr}_n} = \mathbf{R}_{\text{sr}_n}^{-1} \mathbf{P}_{\text{sr}_n} \quad (11)$$

$$\mathbf{W}_d = \mathbf{R}_d^{-1} \mathbf{P}_d \quad (12)$$

where  $\mathbf{R}_{\text{sr}_n} = E[\mathbf{r}_{\text{sr}_n}[i] \mathbf{r}_{\text{sr}_n}^H[i]]$ ,  $\mathbf{P}_{\text{sr}_n} = E[\mathbf{r}_{\text{sr}_n}[i] \mathbf{s}^H[i]]$ ,  $\mathbf{R}_d = E[\mathbf{r}_d[i] \mathbf{r}_d^H[i]]$ , and  $\mathbf{P}_d = E[\mathbf{r}_d[i] \mathbf{s}^H[i]]$ . The MSEs at the destination and  $n$ th relay are then, respectively, given by

$$\sigma_{\text{s}}^2 - \text{trace}(\mathbf{P}_d^H \mathbf{R}_d^{-1} \mathbf{P}_d) \quad (13)$$

$$\sigma_{\text{s}}^2 - \text{trace}(\mathbf{P}_{\text{sr}_n}^H \mathbf{R}_{\text{sr}_n}^{-1} \mathbf{P}_{\text{sr}_n}) \quad (14)$$

where  $\sigma_{\text{s}}^2 = E[\mathbf{s}^H[i] \mathbf{s}[i]]$ .

### B. Optimal MMSE SIC Reception

Nonlinear reception offers performance advantages in MIMO systems by assisting in the mitigation of the multi-antenna interference; however, this is at the cost of increased complexity. By using MMSE SIC, advantages can be obtained while avoiding the levels of complexity associated with other nonlinear methods such as sphere decoding and full maximum likelihood decoding. The implementation of SIC in MIMO systems has been addressed in previous works, but cooperative DF MIMO systems add an additional layer of complexity to the process due to the two reception phases and multiple independent nodes transmitting simultaneously, [13]–[17]. To perform SIC at the destination, we begin with the destination received vector, where the contribution of the  $l$ th  $-1$  data streams has been removed for the  $l$ th layer of decoding

$$\mathbf{r}_d^l[i] = \begin{bmatrix} \mathbf{r}_{\text{sd}}^l[i] \\ \mathbf{r}_{\text{rd}}^l[i] \end{bmatrix} \quad (15)$$

where

$$\mathbf{r}_{rd}^l[i] = \mathbf{r}_{rd}[i] - \mathcal{H}_{rd}[i] \mathcal{A}_r[i] \mathbf{T}_r[i] \hat{\mathbf{s}}_d^{l-1}[i] \quad (16)$$

$$\mathbf{r}_{sd}^l[i] = \mathbf{r}_{sd}[i] - \mathbf{H}_{sd}[i] \mathbf{A}_s[i] \mathbf{T}_s[i] \hat{\mathbf{s}}_d^{l-1}[i]. \quad (17)$$

The detection and estimation of the  $l$ th data stream at the destination are performed using relayed and direct signals. To avoid auxiliary calculations and minimize complexity, the interference cancellation is unordered and done in a batch process where a single destination symbol estimate is used to generate the cancellation terms from all the relevant source and relay antennas. The estimated symbol interference cancellation vector is given by

$$\hat{\mathbf{s}}_d^l[i] = \begin{bmatrix} \hat{s}_d^l[i] \\ \vdots \\ \hat{s}_d^l[i] \end{bmatrix}_{N_r} \quad (18)$$

where

$$\hat{\mathbf{s}}_d^0[i] = \begin{bmatrix} 0 \\ \vdots \\ 0 \end{bmatrix}_{N_{as}} \quad \text{for } l=0 \quad \hat{\mathbf{s}}_d^l[i] = \begin{bmatrix} \hat{s}_d^1[i] \\ \vdots \\ \hat{s}_d^l[i] \\ \mathbf{0}_{(N_{as}-l) \times 1} \end{bmatrix} \quad \text{for } l=1 \dots N_{as}-1. \quad (19)$$

The destination Wiener filter for the  $l$ th layer is then given by

$$\mathbf{w}_d^l = (\mathbf{R}_d^l)^{-1} \mathbf{p}_d^l \quad (20)$$

where  $\mathbf{R}_d^l = E[\mathbf{r}_d^l[i](\mathbf{r}_d^l[i])^H]$  and  $\mathbf{p}_d^l = E[\mathbf{r}_d^l[i](s^l[i])^*]$  are the associated correlation matrices, and  $s^l[i]$  is the  $l$ th element of the symbol vector  $\mathbf{s}[i]$ . MMSE SIC reception is also undertaken at each relay, where the modified received signal for the  $l$ th layer of decoding at the  $n$ th relay is given by

$$\mathbf{r}_{srn}^l[i] = \mathbf{r}_{srn}[i] - \mathbf{H}_{srn}[i] \mathbf{A}_s[i] \mathbf{T}_s[i] \hat{\mathbf{s}}_{rn}^{l-1}[i] \quad (21)$$

where

$$\hat{\mathbf{s}}_{rn}^0[i] = \begin{bmatrix} 0 \\ \vdots \\ 0 \end{bmatrix}_{N_{as}} \quad \text{for } l=0 \quad \hat{\mathbf{s}}_{rn}^l[i] = \begin{bmatrix} \hat{s}_{rn}^1[i] \\ \vdots \\ \hat{s}_{rn}^l[i] \\ \mathbf{0}_{(N_{as}-l) \times 1} \end{bmatrix} \quad \text{for } l=1 \dots N_{as}-1 \quad (22)$$

form the estimated symbol interference cancellation vector. The associated Wiener filter is then given by

$$\mathbf{w}_{rn}^l = (\mathbf{R}_{rn}^l)^{-1} \mathbf{p}_{rn}^l \quad (23)$$

where  $\mathbf{R}_{rn}^l = E[\mathbf{r}_{rn}^l[i](\mathbf{r}_{rn}^l[i])^H]$  and  $\mathbf{p}_{rn}^l = E[\mathbf{r}_{rn}^l[i](s^l[i])^*]$  are the required correlation matrices. The MSEs resulting from SIC at the relays and destination are, respectively, given by

$$\text{MSE}_{rn} = \sigma_s^2 - \sum_{j=1}^{N_{as}} \left( (\mathbf{P}_{rn}^j)^H (\mathbf{R}_{rn}^j)^{-1} \mathbf{P}_{rn}^j \right) \quad (24)$$

$$\text{MSE}_d = \sigma_s^2 - \sum_{j=1}^{N_{as}} \left( (\mathbf{P}_d^j)^H (\mathbf{R}_d^j)^{-1} \mathbf{P}_d^j \right) \quad (25)$$

where the summation is formed from the MSE contribution of each element of the estimated symbol vector  $\hat{\mathbf{s}}[i]$ , and the required structures are analogous to those utilized in (13).

### C. Iterative Adaptive Linear MMSE Reception

Adaptive reception and interference suppression is a low-complexity and practical alternative to the two previous techniques. By iteratively converging toward the optimal estimation and interference suppression filter, the computational expense can be significantly reduced. The derivation of this approach begins as in Section III-A with an MSE optimization problem given by

$$\mathbf{W}_d^{\text{opt}}[i] = \arg \min_{\mathbf{W}_d[i]} E \left[ \|\mathbf{s}[i] - \mathbf{W}_d^H[i] \mathbf{r}_d[i]\|^2 \right]. \quad (26)$$

However, instead of solving optimally, a stochastic gradient approach is chosen. The gradient is taken with respect to the filter  $\mathbf{W}_d$  and a recursive least mean square (LMS) update equation formed with the aid of a step-size  $\mu$ . This results in

$$\mathbf{W}_d[i+1] = \mathbf{W}_d[i] + \mu_d \mathbf{r}_d[i] \mathbf{e}_d^H[i] \quad (27)$$

where

$$\mathbf{e}_d[i] = \mathbf{s}[i] - \mathbf{W}_d^H[i] \mathbf{r}_d[i] \quad (28)$$

and  $\mathbf{s}[i]$  is provided by a known training sequence or in a decision directed manner. A similar approach is also taken for reception at the relay nodes, resulting in the following LMS update equations:

$$\mathbf{W}_{rn}[i+1] = \mathbf{W}_{rn}[i] + \mu_r \mathbf{r}_{rn}[i] \mathbf{e}_{rn}^H[i] \quad (29)$$

where

$$\mathbf{e}_{rn}[i] = \mathbf{s}[i] - \mathbf{W}_{rn}^H[i] \mathbf{r}_{rn}[i]. \quad (30)$$

Alternatively, a designer can employ more sophisticated estimation algorithms such as reduced-rank techniques [39]–[44].

### D. Mutual Information

Maximization of the enhanced capacity and sum rate that cooperative MIMO networks offer is another important feature of reception techniques in cooperative MIMO systems. In [34] and [35], the formulation of the MI of a conventional MIMO system is studied. Treating the cooperative system considered in this paper in a similar manner, it is possible to arrive at an expression for the MI of the first and second phases. Fundamentally, the MI of a phase is given by the difference between the differential entropy and the conditional differential entropy of the received signal when the transmit data are known. This can be expressed as

$$I_{rn}(\mathbf{s}; \mathbf{r}_{rn}) = H(\mathbf{r}_{rn}) - H(\mathbf{r}_{rn} | \mathbf{s}) \quad (31)$$

$$I_d(\mathbf{s}; \mathbf{r}_d) = H(\mathbf{r}_d) - H(\mathbf{r}_d | \mathbf{s}) \quad (32)$$

for reception at the  $N_r$ th during first phase and reception at the destination during the second phase, respectively. With further

manipulation presented in [34] and [35], the MI of the first and second phases can respectively be expressed as

$$I_{r_n}(\mathbf{s}; \mathbf{r}_{r_n}) = \log_2 \det \left( \mathbf{I}_{N_a} + E \left[ \mathbf{H}_{sr_n}[i] \mathbf{A}_s[i] \mathbf{T}_s[i] \hat{\mathbf{s}}[i] \hat{\mathbf{s}}^H[i] \right. \right. \\ \left. \left. \times \mathbf{T}_s^H[i] \mathbf{A}_s^H[i] \mathbf{H}_{sr_n}^H[i] \right] \right) \quad (33)$$

$$I_d(\mathbf{s}; \mathbf{r}_{rd}) = \log_2 \det \left( \mathbf{I}_{N_a} + E \left[ \mathcal{H}_{rd}[i] \mathcal{A}_r[i] \mathcal{T}_r[i] \hat{\mathbf{s}}[i] \hat{\mathbf{s}}^H[i] \right. \right. \\ \left. \left. \times \mathcal{T}_r^H[i] \mathcal{A}_r^H[i] \mathcal{H}_{rd}^H[i] \right] \right). \quad (34)$$

#### IV. TRANSMIT DIVERSITY OPTIMIZATION

The added spatial diversity and multiplexing that cooperative MIMO achieves compared to single antenna systems make it an attractive transmission methodology. However, undiscerning use of the available channels when a number may have poor transmission characteristics leads to performance degradation, loss of achievable diversity and capacity, and increased interference. These problems can be alleviated by the intelligent selection of transmit antennas of each phase in a process we term TDS. Although this will reduce the total diversity advantage available in the system, it will increase the diversity achieved by the uncoded MMSE-based reception techniques. The requirement to maintain maximum multiplexing gain in the system prohibits selection at the source node, and therefore, we concentrate on selection at the relays, where the matrix  $\mathcal{T}_r[i]$  provides the means to do so in both DF and AF systems. By optimizing the selection of  $\mathcal{T}_r[i]$ , it is possible to optimize the performance of the system as a whole. The limited number of relay antennas and the finite number of possible states of each (on/off) make the selection of  $\mathcal{T}_r[i]$  a discrete and permutation-based task. Therefore, we formulate the selection task for each reception technique as a discrete optimization problem.

##### A. Optimal Linear MMSE Reception

The availability of MSE information from the MMSE reception of second phase makes optimization based on this metric an attractive and low-cost procedure, and therefore, one we will use. We begin by forming a discrete cost function given by

$$\mathcal{T}_r^{\text{opt}} = \arg \min_{\mathcal{T}_r[i] \in \Omega_T} \mathcal{C}[i, \mathcal{T}_r[i]] \\ = \arg \min_{\mathcal{T}_r[i] \in \Omega_T} E \left[ \|\mathbf{s}[i] - \mathbf{W}_d[i, \mathcal{T}_r[i]] \mathbf{r}_d[i, \mathcal{T}_r[i]]\|^2 \right] \quad (35)$$

where the TDS matrix is chosen from a finite set of candidates denoted by  $\Omega_T$ . The solution to (35) can be found by searching the set  $\Omega_T$  that has been generated from the permutations of

active antennas over all the relays. However, the cardinality of such a set is extremely large even at modest numbers of relays and antennas. When all antennas are active and interrelay communication is assumed,  $|\Omega_T| = (N_{ar} \times N_r)!$  and rises further when not all antennas are required to be active. Searching of such a set is clearly impractical, and therefore, methods to reduce  $|\Omega_T|$  are required. We start by transforming the problem from a permutation based to combinatorial based by prohibiting interrelay communications and restricting the allocation of data streams to antennas. The distance between relays and the additional computational expense of interrelay communication lead us to the realistic and common assumption of no interrelay communication that restricts relays to only forward data that have been decoded locally. In addition to this, if  $N_{ar} = N_{as}$  at each relay, then it is possible to preallocate data streams to transmit antennas and therefore remove complexity from the relaying process while reducing  $|\Omega_T|$  without bias toward certain data streams. To do this, we preallocate data streams in such a way to restrict each stream to be transmitted from its correspondingly numbered antennas at each relay. The final condition that we place on the selection of transmit antennas is to specify the size of the subset of active antennas, a value denoted  $N_{asub}$ , where  $1 < N_{asub} < N_r$ . This constraint ensures that a minimum level of achievable diversity is available while ensuring increased robustness by preventing the use of poor quality channels. The combined effect of these conditions and restrictions result in a reduced set  $\Omega_T$ , which has a cardinality of

$$|\Omega_T| = \binom{N_{ar} N_r}{N_{asub}} \quad (36)$$

where  $\text{trace}(\mathcal{T}_r[i]) = N_{asub}$  when TDS is employed. This updated candidate set of TDS matrices can now be inserted into the MSE cost function given by (35), and (13) and (14) are used to provide the necessary MSE information to solve (35).

##### B. Optimal MMSE SIC Reception

The process of TDS can be extended to SIC and offers the prospect of performance advantages over that of standard SIC. As previously set out, the process of TDS is a discrete optimization task whose performance and complexity are heavily dependent on the cardinality of the candidate set of solutions. Consequently, the considered set of solutions will be refined as it has been for in Section IV for optimal linear MMSE reception. This refined set can then be placed in a TDS SIC optimization function, giving

$$\mathcal{T}_r^{\text{opt}} = \arg \min_{\mathcal{T}_r[i] \in \Omega_T} \mathcal{C}^{\text{sic}}[i, \mathcal{T}_r[i]] \\ = \arg \min_{\mathcal{T}_r[i] \in \Omega_T} \sum_{l=1}^{N_{as}} E \left[ \left\| \mathbf{s}^l[i] - \mathbf{w}_d^l[i, \mathcal{T}_r[i]] \mathbf{r}_d^l[i, \mathcal{T}_r[i]] \right\|^2 \right]. \quad (37)$$

As before, the task is to then select the optimal TDS matrix from the set  $\Omega_T$  with respect to MSE performance.

### C. MI and Capacity Maximization

TDS can also be applied to MI and capacity maximization. Once again, we will concentrate upon the second phase due to the lack of antenna redundancy at the source node. By transforming the MI framework given in Section III-D into a maximization procedure and inserting (34), we arrive at

$$\begin{aligned} \mathcal{T}_r^{\text{opt}} &= \arg \max_{\mathcal{T}_r[i] \in \Omega_T} I_T(\mathbf{s}; \mathbf{r}_{\text{rd}}, i, \mathcal{T}_r[i]) \\ &= \arg \max_{\mathcal{T}_r[i] \in \Omega_T} \log_2 \det \left( \mathbf{I}_{N_a} + \frac{1}{N_{\text{a\_sub}} \sigma_{\eta_{\text{rd}}}^2} \mathcal{H}_{\text{rd}}[i] \mathcal{T}_r[i] \right. \\ &\quad \left. \times \mathbf{R}_{\hat{\mathbf{s}}} \mathcal{T}_r^H[i] \mathcal{H}_{\text{rd}}^H[i] \right) \end{aligned} \quad (38)$$

where the autocorrelation matrix of the transmitted relay data is given by

$$\mathbf{R}_{\hat{\mathbf{s}}} = E \left[ \hat{\mathbf{s}}[i] \hat{\mathbf{s}}^H[i] \right] = \begin{bmatrix} \mathbf{I}_{N_a} & \cdots & \mathbf{I}_{N_a} \\ \vdots & \ddots & \vdots \\ \mathbf{I}_{N_a} & \ddots & \mathbf{I}_{N_a} \end{bmatrix}. \quad (39)$$

Once again, the optimization problem posed by (39) is a discrete combinatorial problem, where the finite set  $\Omega_T$  contains the potential solutions, and it is required to search a solution.

### D. Iterative Adaptive Linear MMSE Reception

Here, we pose an optimization problem based on low-complexity continuous iterative adaptive linear MMSE reception and the discrete TDS. This is again a joint optimization problem, but the solution to (10) is iteratively found as opposed to that optimally calculated in Section III-A. Placed into a single continuous-discrete hybrid optimization, we arrive at

$$\begin{aligned} &[\mathbf{W}_d^{\text{opt}}[i], \mathcal{T}_r^{\text{opt}}[i]] \\ &= \arg \min_{\mathbf{W}_d[i], \mathcal{T}_r[i] \in \Omega_T} \mathcal{C}^{\text{ad}}[i, \mathcal{T}_r[i], \mathbf{W}_d[i]] \\ &= \arg \min_{\mathbf{W}_d[i], \mathcal{T}_r[i] \in \Omega_T} E \left[ \|\mathbf{s}[i] - \mathbf{W}_d[i, \mathcal{T}_r[i]] \mathbf{r}_d[i, \mathcal{T}_r[i]]\|^2 \right]. \end{aligned} \quad (40)$$

However, due to the use of an LMS algorithm to arrive at  $\mathbf{W}_d[i]$ , ideal MSE information is not available. Consequently, the expectation is required to be replaced with an ensemble average using the destination's squared instantaneous estimation error given by (28). This results in an updated expression for  $\mathcal{C}^{\text{ad}}$  given by

$$\begin{aligned} &\mathcal{C}^{\text{ad}}[i, \mathcal{T}_r[i], \mathbf{W}_d[i]] \\ &= \frac{1}{i} \sum_{k=1}^i \|\mathbf{s}[k] - \mathbf{W}_d[k, \mathcal{T}_r[i]] \mathbf{r}_d[k, \mathcal{T}_r[i]]\|^2. \end{aligned} \quad (41)$$

Additional complexity savings are possible through the use of a recursive averaging procedure instead of the summation

in (41). However, reducing the complexity further by using the unaveraged instantaneous error is not practical due to the AWGN and the unreliable estimates of  $\mathcal{T}_r[i]$ , even at high values of  $i$ .

## V. RELAY SELECTION

In Section IV, optimization of the system is considered through the process of TDS. However, due to the separation between the two phases, the advantages are restricted by the performance of the first phase. The primary problem that exists for MMSE reception with TDS is the possibility of pairing a high-quality second-phase channel with a poor-quality first-phase channel, a problem arising from the lack of consideration of first-phase channel conditions in the TDS process. This can be alleviated through optimization of the pairing of channels. A second aspect of the discrete TDS optimization and methods to solve it is the dependence of their performance and convergence on the cardinality of the set  $\Omega_T$ ; therefore, reducing this further is desirable. However, first-phase performance metrics are not directly available at the destination, interrelay communication is assumed not available, and there is no antenna redundancy at the source. Consequently, direct optimization of the first phase is not possible. To address these issues, we propose to transfer the burden of first-phase optimization onto the destination by performing a joint optimization procedure where the TDS set is optimized based on performance metrics from the relays. This is done by forwarding the available MSE and MI of each relay to the destination and then removing members of the set  $\Omega_T$  based on the first-phase performance of their relays. It is then possible to reduce the probability of a mismatch between the first- and second-phase channels while reducing the size of the TDS set by eliminating the TDS matrices contained within  $\Omega_T$  that transmit from the relay(s) with the highest MSE/lowest MI.

### A. Optimal Linear MMSE Reception

The task of RS is again a discrete combinatorial problem and can be expressed as a cost function. The selection of the poorest performing relay based on its MSE performance under optimal linear reception can be expressed as

$$\begin{aligned} r^{\text{opt}} &= \arg \max_{r[i] \in \Omega_R} \mathcal{F}[i, r[i]] \\ &= \arg \max_{r[i] \in \Omega_R} E \left[ \left\| \mathbf{s}[i] - \mathbf{w}_{\text{sr}[i]}^H[i] \mathbf{r}_{\text{sr}[i]}[i] \right\|^2 \right] \end{aligned} \quad (42)$$

where the set  $\Omega_R$  contains the candidate relays.

For the selection of multiple or  $N_{\text{rem}}$  relays, the MSE of subsets of relays needs to be evaluated. This is done by populating  $\Omega_R$  with vectors of dimensionality  $N_{\text{rem}} \times 1$ , which contain all possible length  $N_{\text{rem}}$  combinations of relay indices such that

$$|\Omega_R| = \binom{N_r}{N_{\text{rem}}} \quad (43)$$

or alternatively, all possible relay subsets of cardinality  $N_{\text{rem}}$ . When placed into an optimization framework, this yields

$$\begin{aligned} \mathbf{r}^{\text{opt}} &= \arg \max_{\mathbf{r}^{[i]} \in \Omega_R} \sum_{j=1}^{N_{\text{rem}}} \mathcal{F} [i, \mathbf{r}_j [i]] \\ &= \arg \max_{\mathbf{r}^{[i]} \in \Omega_R} \sum_{j=1}^{N_{\text{rem}}} E \left[ \left\| \mathbf{s} [i] - \mathbf{w}_{\text{sr}, \mathbf{r}_j [i]}^H [i] \mathbf{r}_{\text{sr}, \mathbf{r}_j [i]} [i] \right\|^2 \right] \end{aligned} \quad (44)$$

where  $\mathbf{r}_j$  represents the  $j$ th element of the vector  $\mathbf{r}$ . Following the solution of (42) or (44), set reduction can commence. This is where the TDS matrices that involve transmission from the relay(s) contained within  $\mathbf{r}^{\text{opt}}$  are removed from  $\Omega_T$ . This reduced TDS set is termed  $\hat{\Omega}_T$ , and its cardinality is given by

$$|\hat{\Omega}_T| = \binom{N_{\text{ar}}(N_r - N_{\text{rem}})}{N_{\text{asub}}}. \quad (45)$$

The TDS optimization given by (35) then operates over this set. As can be seen from (45), increasing  $N_{\text{rem}}$  leads to a decrease in  $|\hat{\Omega}_T|$  and, therefore, the complexity of the optimization process. However, high values of  $N_{\text{rem}}$  greatly restrict the choice of TDS matrices and, therefore, second-phase channels, leading to an increased probability of first- and second-phase channel mismatches. Consequently, there is a balance to be struck between system performance and optimization complexity when choosing  $N_{\text{rem}}$ . In general,  $N_{\text{rem}}$  should remain low in comparison with  $N_r$ ; however, finer adjustment depends on the variance of the qualities of the first- and second-phase channels.

### B. Optimal MMSE SIC Reception

The SIC receiver when implemented in MIMO networks has the ability to offer considerable advantages over linear reception techniques. However, when applied to DF cooperative networks, the separation of the first and second phases can lead to performance degradation and the effective operation of SIC breaking down. In the SIC framework set out in Sections III-B and IV-B, the estimated relay transmit data are formed from a single estimate based on the receive signals from the relayed and direct transmissions. This method operates on the assumption that identical symbol estimates are obtained at each relay for every time instant and that this also occurs at the destination node. However, this assumption is liable to break down. RS can help mitigate this problem by identifying and removing the relay(s) most likely to break the identical relay symbol estimate assumption and then refining the TDS set accordingly.

This is achieved by identifying the relay(s) with the highest MSE as for the optimal linear reception. The discrete MSE cost function to identify the highest MSE relay(s) is given by

$$\begin{aligned} r^{\text{opt}} &= \arg \max_{r^{[i]} \in \Omega_R} \mathcal{F}^{\text{sic}} [i, r^{[i]}] \\ &= \arg \max_{r^{[i]} \in \Omega_R} \sum_{l=1}^{N_{\text{as}}} E \left[ \left\| s^l [i] - \mathbf{w}_{\text{sr}, r^{[i]}}^H [i] \mathbf{r}_{\text{sr}, r^{[i]}}^l [i] \right\|^2 \right] \end{aligned} \quad (46)$$

for the single relay case. Extending RS to multiple relays yields

$$\begin{aligned} \mathbf{r}^{\text{opt}} &= \arg \max_{\mathbf{r}^{[i]} \in \Omega_R} \sum_{j=1}^{N_{\text{rem}}} \mathcal{F}^{\text{sic}} [i, \mathbf{r}_j [i]] \\ &= \arg \max_{\mathbf{r}^{[i]} \in \Omega_R} \sum_{j=1}^{N_{\text{rem}}} \sum_{l=1}^{N_{\text{as}}} E \left[ \left\| s^l [i] - \mathbf{w}_{\text{sr}, \mathbf{r}_j [i]}^H [i] \mathbf{r}_{\text{sr}, \mathbf{r}_j [i]}^l [i] \right\|^2 \right]. \end{aligned} \quad (47)$$

The selected relays are then removed from the candidate TDS set to form  $|\hat{\Omega}_T|$ , which (37) then operates over.

### C. MI and Capacity Maximization

We next address the introduction of RS and its effect on the performance and complexity of the MI TDS process. Equation (39) does not directly take account of the performance of the source-relay transmission, and therefore, there is a likelihood of  $I_{\text{sr}_n} < I_{\text{rn}d}$ . We propose removing from consideration the relays that have the lowest MI between the transmitted data  $\mathbf{s}$  and its received signal  $\mathbf{r}_{\text{sr}_n}$ . This can be achieved by the discrete combinatorial optimization problem given by

$$\begin{aligned} \mathbf{r}^{\text{opt}} &= \arg \min_{\mathbf{r}^{[i]} \in \Omega_R} \sum_{j=1}^{N_{\text{rem}}} I_{\text{R}} \left( \mathbf{s}; \mathbf{r}_{\text{sr}, \mathbf{r}_j [i]}, i, \mathbf{r}_j [i] \right) \\ &= \arg \min_{\mathbf{r}^{[i]} \in \Omega_R} \sum_{j=1}^{N_{\text{rem}}} \log_2 \det \left( \mathbf{I}_{N_a} + \frac{1}{N_a \sigma_{\eta_{\text{sr}}}^2} \mathbf{H}_{\text{sr}, \mathbf{r}_j [i]} [i] \right. \\ &\quad \left. \times \mathbf{R}_{\mathbf{s}} \mathbf{H}_{\text{sr}, \mathbf{r}_j [i]}^H [i] \right) \end{aligned} \quad (48)$$

where the autocorrelation matrix of the transmitted data is given by

$$\mathbf{R}_{\mathbf{s}} = E [\mathbf{s} [i] \mathbf{s}^H [i]] = \mathbf{I}_{N_a}. \quad (49)$$

As before, the removal of a relay reduces the cardinality of the set over which TDS is performed and therefore improves the speed and/or complexity of the corresponding optimization.

### D. Iterative Adaptive Linear MMSE Reception

To further illustrate the use of the discrete approaches proposed, we apply RS to adaptive linear reception. As for optimal linear reception, the optimal relay(s) will be selected in accordance with the optimization problem given by

$$\begin{aligned} \mathbf{r}^{\text{opt}} &= \arg \max_{\mathbf{r}^{[i]} \in \Omega_R} \sum_{j=1}^{N_{\text{rem}}} \mathcal{F}^{\text{ad}} [i, \mathbf{r}_j [i]] \\ &= \arg \max_{\mathbf{r}^{[i]} \in \Omega_R} \sum_{j=1}^{N_{\text{rem}}} E \left[ \left\| \mathbf{s} [i] - \mathbf{w}_{\text{sr}, \mathbf{r}_j [i]}^H [i] \mathbf{r}_{\text{sr}, \mathbf{r}_j [i]} [i] \right\|^2 \right]. \end{aligned} \quad (50)$$

However, as before, in the LMS adaptation, the expectation is not performed, and the MSE is replaced with an ensemble average based on the instantaneous squared relay

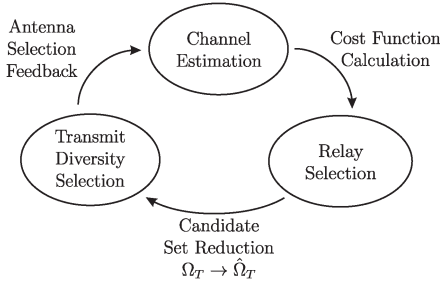

Fig. 2. Algorithm flow diagram.

estimation error given by (30). Reformulating  $\mathcal{F}^{\text{ad}}$  accordingly, we arrive at

$$\mathcal{F}^{\text{ad}}[i, \mathbf{r}_j[i]] = \frac{1}{i} \sum_{k=1}^i \left[ \left\| \mathbf{s}[k] - \mathbf{w}_{\text{sr}_{r_j}[k]}^H [i] \mathbf{r}_{\text{sr}_{r_j}[i]}[k] \right\|^2 \right]. \quad (51)$$

### E. Amplify-and-Forward

Due to the lack of decoding at each relay in an AF system, MSE information is not available, and therefore, a secondary optimization criteria is required. In this paper, we choose the end-to-end SNR of each relay branch and perform RS based on the branch(es) with the lowest SNR. Interpreting this in the multiple RS framework yields

$$\mathbf{r}^{\text{opt}} = \arg \min_{\mathbf{r}^{[i]} \in \Omega_R} \sum_{j=1}^{N_{\text{rem}}} \mathcal{K}[i, \mathbf{r}_j[i]] \quad (52)$$

where  $\mathcal{K}[i, \mathbf{r}_j[i]]$  is defined in (53), shown at the bottom of the page. The end-to-end SNR given by (53) is constructed from the compounded channels of the AF system. The numerator is formed from the signal power transmitted through each relay in the system, and the noise in the denominator is formed from the second-phase noise ( $\sigma_{\text{sr}}^2 \mathbf{I}_{N_a}$ ) and the amplified first-phase noise ( $\mathbf{A}_{\text{r}_{r_j}[i]d}[i] \sigma_{\text{sr}}^2 \mathbf{I}_{N_a} \mathbf{A}_{\text{r}_{r_j}[i]d}^H [i]$ ).

## VI. PROPOSED ALGORITHMS

In this section, we present algorithms to solve the optimization problems of Sections IV and V. We propose that the TDS and RS schemes operate in a joint and cyclic fashion, where RS constantly refines the set that TDS operates over. However, to obtain solutions to the optimization problems, backward CSI is required at the relays and destination. Due to the cyclic nature of the proposed optimization framework, it is possible to insert channel estimation without interrupting the process, and a flow diagram given in Fig. 2 shows this.

The optimal but most complex method to obtain solutions to the range of TDS and RS optimization problems is to perform

TABLE I  
PROPOSED DISCRETE STOCHASTIC TDS ALGORITHM  
FOR LINEAR MMSE RECEPTION

Step
<b>1. Initialization</b> choose $\mathcal{T}[1] \in \Omega_T, \mathcal{T}^W[1] \in \Omega_T, \pi_T[1, \mathcal{T}[1]] = 1,$ $\pi_T[1, \tilde{\mathcal{T}}] = 0$ for $\tilde{\mathcal{T}} \neq \mathcal{T}[1]$
<b>2. For the time index <math>i = 1, 2, \dots, N</math></b> choose $\mathcal{T}^C[i] \in \Omega_T$
<b>3. Comparison and update of the worst performing relay</b> if $C[i, \mathcal{T}^C[i]] < C[i, \mathcal{T}^W[i]]$ then $\mathcal{T}^W[i+1] = \mathcal{T}^C[i]$ otherwise $\mathcal{T}^W[i+1] = \mathcal{T}^W[i]$
<b>4. State occupation probability (SOP) vector update</b> $\pi_T[i+1] = \pi_T[i] + \mu[i+1](\mathbf{v}_{\mathcal{T}^W[i+1]} - \pi_T[i])$ where $\mu[i] = 1/i$
<b>5. Determine the largest SOP vector element and select the optimum TDS matrix</b> if $\pi_T[i+1, \mathcal{T}^W[i+1]] > \pi_T[i+1, \mathcal{T}[i]]$ then $\mathcal{T}[i+1] = \mathcal{T}^W[i+1]$ otherwise $\mathcal{T}[i+1] = \mathcal{T}[i]$

an exhaustive search of the respective sets at each time instant. However, due to the power consumption and complexity constraints on nodes within the system, such an approach is not possible; however, it can act as a lower bound on performance. Iterative methods that converge to the optimal solution present an alternative low-complexity approach, and therefore, this family of methods will be used in this paper. Conventional iterative algorithms, including LMS and RLS, are unsuitable for discrete problems, and therefore, discrete stochastic algorithms (DSAs) are chosen. In this paper, a low-complexity DSA first presented in [30] and later used [5] is selected. Each set of optimization problems can then be jointly and iteratively solved at little additional computational cost above that of the reception and decoding processes at each time instant.

For the optimization problems of Sections IV and V, we propose a low-complexity DSA that jointly optimizes RS and TDS in accordance with (35) and (42), (37) and (46), (48) and (39), and (40) and (50), and converges to the optimal exhaustive solution. First, in Table I, we present the TDS segment of the algorithm that optimizes the selection of the TDS matrix  $\mathcal{T}_r$  with regard to optimal linear MMSE reception. At each iteration, the MSE of a randomly chosen candidate TDS matrix ( $\mathcal{T}_r^C$ ) (step 2) and that of the best performing TDS matrix currently known ( $\mathcal{T}_r^B$ ) are calculated (step 3). Via a comparison, the lower MSE TDS matrix is designated  $\mathcal{T}_r^B$  for the next iteration (step 3). The current solution and TDS matrix chosen for transmission ( $\mathcal{T}_r$ ) is denoted as the current optimum and is the TDS matrix that has occupied  $\mathcal{T}_r^B$  most frequently over the course of the packet up to the  $i$ th time instant. This averaging/selection process is performed by allocating each member of  $\Omega_T$  a  $|\Omega_T| \times 1$  unit vector,  $\mathbf{v}_l$ , which has a 1 in its corresponding position in  $\Omega_T$ , i.e.,  $\mathbf{v}_{\mathcal{T}_r^B[i]}$  is the label of the best performing TDS matrix at the  $i$ th iteration. The current optimum is then chosen and tracked by means of a  $|\Omega_T| \times 1$  state occupation probability vector  $\pi_T$ . This vector is updated at each iteration by adding  $\mathbf{v}_{\mathcal{T}_r^B[i+i]}$

$$\mathcal{K}[i, \mathbf{r}_j[i]] = \frac{\text{trace} \left( \mathbf{H}_{\text{r}_{r_j}[i]d}[i] \mathbf{A}_{\text{r}_{r_j}d}[i] \mathbf{H}_{\text{sr}_{r_j}[i]} [i] \mathbf{A}_s [i] \mathbf{A}_s^H [i] \mathbf{H}_{\text{sr}_{r_j}[i]}^H [i] \mathbf{A}_{\text{r}_{r_j}[i]d}^H [i] \mathbf{H}_{\text{r}_{r_j}[i]d}^H [i] \right)}{\text{trace} \left( \mathbf{H}_{\text{r}_{r_j}[i]d}[i] \mathbf{A}_{\text{r}_{r_j}d}[i] \sigma_{\text{sr}}^2 \mathbf{I}_{N_a} \mathbf{A}_{\text{r}_{r_j}[i]d}^H [i] \mathbf{H}_{\text{r}_{r_j}[i]d}^H [i] + \sigma_{\text{rd}}^2 \mathbf{I}_{N_a} \right)} \quad (53)$$



TABLE II  
PROPOSED DISCRETE STOCHASTIC RS ALGORITHM  
FOR LINEAR MMSE RECEPTION

Step
<b>1. Initialization</b>
choose $r[1] \in \Omega_R$ , $r^W[1] \in \Omega_R$ , $\pi_R[1, r[1]] = 1$ , $\pi_R[1, \tilde{r}] = 0$ for $\tilde{r} \neq r[1]$
<b>2. For the time index <math>i = 1, 2, \dots, N</math></b>
choose $r^C[i] \in \Omega_R$
<b>3. Comparison and update of the worst performing relay</b>
if $\mathcal{F}[i, r^C[i]] > \mathcal{F}[i, r^W[i]]$ then $r^W[i+1] = r^C[i]$ otherwise $r^W[i+1] = r^W[i]$
<b>4. State occupation probability (SOP) vector update</b>
$\pi_R[i+1] = \pi_R[i] + \mu[i+1](\mathbf{v}_{r^W[i+1]} - \pi_R[i])$ where $\mu[i] = 1/i$
<b>5. Determine the largest SOP vector element and select the optimum relay</b>
if $\pi_R[i+1, r^W[i+1]] > \pi_R[i+1, r[i]]$ then $r[i+1] = r^W[i+1]$ otherwise $r[i+1] = r[i]$
<b>6. TDS Set Reduction</b>
remove members of $\Omega_T$ which utilize $r[i+1]$ ( $\Omega_T \rightarrow \hat{\Omega}_T$ )

and subtracting the previous value of  $\pi_T$  (step 4). The current optimum is then determined by selecting the largest element in  $\pi_T$  and its corresponding entry in  $\Omega_T$  (step 5). Through this process, the current optimum converges toward and tracks the exhaustive solution [30]. An alternative interpretation of the proposed algorithm is to view the transitions  $\mathcal{T}_r^B[i] \rightarrow \mathcal{T}_r^B[i+1]$  as a Markov chain and the members of  $\Omega_T$  as the possible transition states. The current optimum can then be defined as the most visited state.

Table II presents the discrete stochastic RS algorithm that provides the algorithm in Table I with a refined TDS set ( $\Omega_T \rightarrow \hat{\Omega}_T$ ) in accordance with (42). The operation of the RS algorithm in Table II is similar to that of the TDS algorithm but with a reversed inequality of step 3, enabling convergence to the highest MSE relay(s), and the addition of step 6 that performs set reduction, as described in Section V. In Table II, a single relay is selected, but extension to the selection of multiple relays is straightforward and involves replacing  $R$  with the vector form  $\mathbf{r}$  and using the MSE calculation of (44).

To adapt the algorithms in Tables I and II for use with SIC reception, MI optimization, and adaptive reception, a number of alterations are required. These include reversing the inequality of step 3 for MI optimization and replacing the metric calculation functions, also of step 3, for all schemes. Details of the required changes are given in Table III, where alterations with respect to RS are for the selection of multiple relays.

Due to the purely adaptive nature of the schemes when iterative adaptive reception is used, a number of further alterations and clarifications are required for correct operation. First, the updating of the receive filter at the destination for each TDS matrix and the accompanying error calculation occur only when its corresponding TDS matrix is selected as either  $\mathcal{T}$ ,  $\mathcal{T}^C$  or  $\mathcal{T}^W$  during the operation of the algorithm given in Table I. Second, due to the parallel convergence of the relay filters, destination filters, TDS, and RS, an extended convergence period is expected. Consequently, the step size of step 4 ( $\mu[i]$ ) is not suitable since it more heavily weights early samples. To avoid this, a fixed step size is implemented that equally weights all samples and assists convergence at large values of  $i$ .

## VII. ANALYSIS

In this section, we analyze and discuss four major aspects of the proposed algorithms that encompass their advantages over existing methods. The four areas covered are computational complexity, convergence, diversity gain, and feedback requirements.

### A. Complexity

The iterative operation of the TDS algorithms offers a clear complexity advantage over an exhaustive search of the entire set of solutions. These savings result from a significant reduction in the number of calculations at each time instant for each set considered compared to the exhaustive search. However, the complexity benefits are a tradeoff against convergence as is often found in mobile systems. In contrast to this, performing RS in combination with the TDS algorithm improves both convergence and complexity. This results from the low complexity of the RS procedure being outweighed by the saving made from the TDS process operating over the reduced cardinality set  $\hat{\Omega}$ . In Fig. 3, the computational complexity in terms of the (average) total number of complex multiplications and additions is given for the optimal exhaustive methods and the proposed DSA when optimal linear MMSE reception is used. For simplicity and conciseness, in this figure and throughout the remainder of this paper,  $N_a$  is used to refer to the number of antennas at all nodes, where  $N_a = N_{as} = N_{ar} = N_{ad}$ . As one can see, there are substantial complexity savings from the use of the proposed algorithms over the exhaustive solutions; these are savings that increase with the number of relays and total antenna elements in the system. A second feature to highlight are the savings made from introducing RS into the optimal exhaustive and proposed methods. These savings also increase with system size and confirm that those made by RS exceed the cost of its implementation. As one can see from Fig. 3, the savings also increase with  $N_{rem}$ , which is a feature explained by the following relationship:

$$(|\Omega_{R, N_{rem}=2}| - |\Omega_{R, N_{rem}=1}|) \leq \left( \left| \hat{\Omega}_{T, N_{rem}=1} \right| - \left| \hat{\Omega}_{T, N_{rem}=2} \right| \right). \quad (54)$$

Table IV presents the analytical expressions for the complexity of the linear MMSE-based TDS and RS algorithms along with their corresponding exhaustive implementations. The presence of the set cardinality in all expressions accounts for each scheme's complexity dependence on the set over which it operates. Central to the cardinality of  $\Omega_T$  and  $\hat{\Omega}_T$  is the choice of  $N_{asub}$ , as shown by (36) and (45). Consequently, the complexities of the schemes are heavily dependent of the binomial relationship between the number of considered antennas and  $N_{asub}$ . The reasons behind the complexity reduction achieved by the iterative RS algorithm are evident from the expressions for the iterative TDS and iterative TDS with RS. The majority of the savings arise from the difference between  $2|\Omega_T|$  and  $2|\hat{\Omega}_T| + 2|\Omega_R|$ , and by referring back to the set cardinality expressions given by (36), (45), and (43), the characteristics of the lines in Fig. 3 can be accounted for.

TABLE III  
TDS AND RS ALGORITHM ALTERATIONS

	TDS Step 3	RS Step 3
Linear MMSE	if $C[i, \mathcal{T}^C[l]] < C[i, \mathcal{T}^W[l]]$	if $\sum_{j=1}^{N_{\text{rem}}} \mathcal{F}[i, r_j^C[l]] > \sum_{j=1}^{N_{\text{rem}}} \mathcal{F}[i, r_j^W[l]]$
SIC MMSE	if $C^{\text{sic}}[i, \mathcal{T}^C[l]] < C^{\text{sic}}[i, \mathcal{T}^W[l]]$	if $\sum_{j=1}^{N_{\text{rem}}} \mathcal{F}^{\text{sic}}[i, r_j^C[l]] > \sum_{j=1}^{N_{\text{rem}}} \mathcal{F}^{\text{sic}}[i, r_j^W[l]]$
MI	if $I_T(\mathbf{s}; \mathbf{r}_{\text{td}}, i, \mathcal{T}^C[l]) > I_T(\mathbf{s}; \mathbf{r}_{\text{td}}, i, \mathcal{T}^W[l])$	if $\sum_{j=1}^{N_{\text{rem}}} I_R(\mathbf{s}; \mathbf{r}_{\text{td}}, i, r_j^C[l]) < \sum_{j=1}^{N_{\text{rem}}} I_R(\mathbf{s}; \mathbf{r}_{\text{td}}, i, r_j^W[l])$
Linear Adaptive	if $C^{\text{ad}}[i, \mathcal{T}^C[l], \mathbf{W}_d[l]] < C^{\text{ad}}[i, \mathcal{T}^W[l], \mathbf{W}_d[l]]$	if $\sum_{j=1}^{N_{\text{rem}}} \mathcal{F}^{\text{ad}}[i, r_j^C[l]] > \sum_{j=1}^{N_{\text{rem}}} \mathcal{F}^{\text{ad}}[i, r_j^W[l]]$
AF - Linear MMSE and SNR	if $C[i, \mathcal{T}^C[l]] < C[i, \mathcal{T}^W[l]]$	if $\sum_{j=1}^{N_{\text{rem}}} \mathcal{K}[i, r_j^C[l]] < \sum_{j=1}^{N_{\text{rem}}} \mathcal{K}[i, r_j^W[l]]$

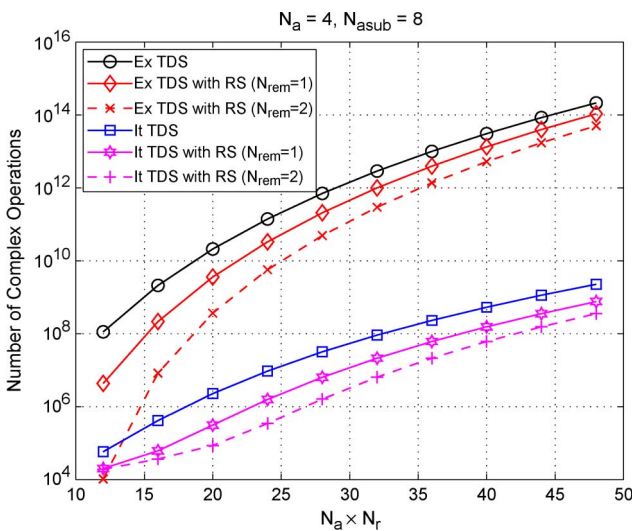

Fig. 3. Computational complexity of optimal exhaustive (Ex) and proposed iterative (It) MMSE schemes.

### B. Feedback Requirements

A significant advantage of the schemes proposed in this paper are their low feedback requirements. No precoding is required at the transmitting nodes, TDS solely operates in the second phase, and all receptions at the receiving nodes only require locally available CSI. Consequently, only the feedback of the TD selections to the relays is required. For RS, relay MSE information is required to be forwarded, which is a process that occurs during the training period. As covered earlier in this paper, TDS can be interpreted as discrete power control with one bit quantization, where the relative transmit power from each antenna is constrained to either 1 or 0. As a result,  $N_{\text{ar}}$  feedback bits are required for TDS at each relay node and a total of  $N_r \times N_{\text{ar}}$  bits for the overall system, a figure that grows linearly with the size of the system. This low feedback rate increases the robustness of the TDS and RS optimization processes and assists in maintaining performance up to significant levels of feedback errors. Additionally, the impact on the capacity of the system is small as only a brief time slot is required for transmission of the feedback information. However, the forwarding of the relay MSE information is subject to quantization, and it is, therefore, the number of quantization levels that determines the rate of the forwarded

data. In this paper, a binary symmetric channel is used to model the feedback and feedforward channels, the quality of which is controlled by the probability of the error term, where  $0 \leq p_e \leq 1$ . Fig. 4 gives the system model when the feedback channel is implemented.

### C. Diversity

A significant benefit of multirelay MIMO systems is the diversity advantage and spatial multiplexing gains they offer. However, obtaining full receive diversity requires complex optimum nonlinear methods such as sphere and maximum likelihood decoding. In this paper, receivers based on linear MMSE filtering have been used, and therefore, it is not possible to obtain the full diversity on offer unless so form of coding is implemented. Nevertheless, the diversity advantage available to uncoded MMSE receivers can be maximized and the accompanying interference suppression improved. The method of TDS and RS restricts the number transmit paths used and therefore lowers the maximum diversity advantage available to the optimum nonlinear receivers from  $d^* = N_{\text{ad}}(1 + (N_r N_{\text{ar}}/N_{\text{as}}))$  to  $d^* = N_{\text{ad}}(N_{\text{asub}}/N_{\text{ar}} + 1)$  when full spatial multiplexing gain is maintained. However, it enables the lower complexity MMSE-based techniques to increase their exploitation of the diversity at an SNR of interest by removing paths that bring little or no advantage to the cooperative transmissions of the first and second phase and dedicating increased transmit power over the remaining transmission routes.

### D. Convergence

Here, we specify the condition under which convergence of the proposed discrete algorithms is guaranteed and discuss the behavior of the proposed algorithms under nonideal conditions. Considering the combinatorial nature of the problems and algorithms presented in this paper, convergence is judged against the optimal exhaustive solution at each time instant. Due to the application of the proposed schemes in practical communications systems, we predominantly concentrate upon BER and squared estimation error as a measure of performance and convergence.

Global convergence of the proposed algorithms is dependent on two assumptions: 1) the independence between the

TABLE IV  
 PROPOSED ALGORITHM COMPLEXITY

Algorithm	No. of Complex Additions and Multiplications
Iterative TDS	$3 \left( 3(N_a N_r)^3 + 2N_a(N_a N_r)^2 + N_a N_r(6N_a^2 + 4N_a + 5) + 8N_a^3 - N_a^2 + N_a + 1 \right) + 5N_r N_a^3 + N_r N_a + N_r + 2 \Omega_T $
Iterative TDS with RS	$3 \left( 3(N_a N_r)^3 + 2N_a(N_a N_r)^2 + N_a N_r(6N_a^2 + 4N_a + 5) + 8N_a^3 - N_a^2 + N_a + 1 \right) + 5N_r N_a^3 + N_r N_a + N_r + 6N_a^3 - 3N_a^2 + 2 \hat{\Omega}_T  + 2 \Omega_R $
Exhaustive TDS	$ \Omega_T  \left( 3(N_a N_r)^3 + 2N_a(N_a N_r)^2 + N_a N_r(6N_a^2 + 4N_a + 5) + 8N_a^3 - N_a^2 + N_a + 1 \right) + 5N_r N_a^3 + N_r N_a + N_r$
Exhaustive TDS with RS	$ \hat{\Omega}_T  \left( 3(N_a N_r)^3 + 2N_a(N_a N_r)^2 + N_a N_r(6N_a^2 + 4N_a + 5) + 8N_a^3 - N_a^2 + N_a + 2 \right) + 7N_r N_a^3 - N_r N_a^2 + N_r N_a + N_r + 2 \Omega_R $

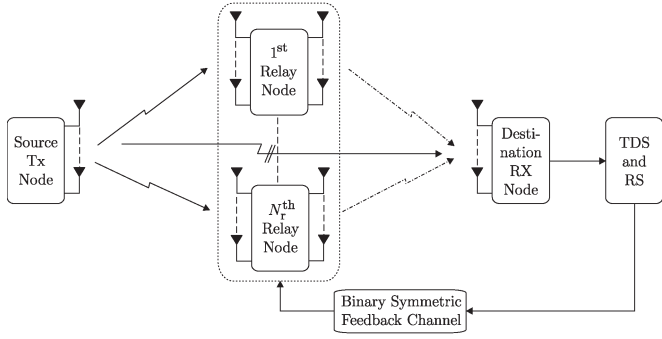

Fig. 4. Cooperative MIMO system model with feedback model.

observations used for the objective function calculations and 2) the satisfaction of

$$\Pr \{ \mathcal{C}_T[i, t^{\text{opt}}] > \mathcal{C}_T[i, t[i]] \} > \Pr \{ \mathcal{C}_T[i, t[i]] > \mathcal{C}_T[i, t^{\text{opt}}] \} \quad (55)$$

$$\Pr \{ \mathcal{C}_T[i, t^{\text{opt}}] > \mathcal{C}_T[i, t^C[i]] \} > \Pr \{ \mathcal{C}_T[i, t[i]] > \mathcal{C}_T[i, t^C[i]] \} \quad (56)$$

for the MMSE TDS and

$$\Pr \{ \mathcal{F}_R[i, r^{\text{opt}}] > \mathcal{F}_R[i, r[i]] \} > \Pr \{ \mathcal{F}_R[i, r[i]] > \mathcal{F}_R[i, r^{\text{opt}}] \} \quad (57)$$

$$\Pr \{ \mathcal{F}_R[i, r^{\text{opt}}] > \mathcal{C}_R[i, r^C[i]] \} > \Pr \{ \mathcal{F}_R[i, r[i]] > \mathcal{F}_R[i, r^C[i]] \} \quad (58)$$

for the MMSE RS. When these conditions are met and independent observations utilized,  $t[i] \rightarrow t^{\text{opt}}$  and  $r[i] \rightarrow r^{\text{opt}}$  are guaranteed of operating independently [5], [30]. However, due to the joint of operation of TDS and RS and the practical difficulties of obtaining numerous independent observations under the system model presented in this paper, the proof of convergence is intractable and, therefore, not guaranteed. Nevertheless, throughout the simulations presented in this paper and extensive experimentation, excellent steady-state convergence performance has been observed. Further support for this conclusion is presented in [5], where no convergence issues were encountered as a result of the lack of independent observations. This, therefore, indicates that the lack of independent observations is not a problem for the proposed schemes; however, the choice of  $\mu$  does need to be taken into consideration. For

example, if a large initial step size is chosen for the TDS process and a small step size for the RS process, it is possible that the TDS process will become trapped in a state associated with a local minimum and therefore fail to converge to the exhaustive TDS with RS solution. Additional care has to be taken when studying the convergence of the schemes that feature adaptive reception. As previously specified, the step size of TDS and RS algorithms is fixed for the adaptive MMSE implementation to aid convergence of TDS and RS at large  $i$  and avoid becoming trapped in a nonoptimal state. Although effective, the rate of convergence will still lag behind the optimal scheme due to not only the convergence of the LMS adaptive filter algorithms and the ensemble error but also the convergence of a total of four algorithms in parallel for TDS with RS. To aid the convergence of all schemes,  $|\Omega_R| \ll |\hat{\Omega}_T|$  to ensure RS converges significantly before TDS ( $|\Omega_R| < |\hat{\Omega}_T|$ ). This, therefore, minimizes the number of TDS iterations performed on the nonoptimal  $\hat{\Omega}_T$  set and assists in ensuring that the detrimental convergence effects of a changing  $\hat{\Omega}_T$  in the initial transient are outweighed by the benefits of TDS operating over a significantly reduced cardinality set.

## VIII. SIMULATIONS

In this section, simulations of the proposed algorithms and existing techniques are presented. For all schemes, comparisons will be given between the optimal exhaustive (exhaustive TDS and exhaustive TDS and RS), the standard cooperative system (no TDS), noncooperative transmission (noncooperative), and iterative (iterative TDS and iterative TDS and RS) implementations. QPSK modulation is used, and equal power allocation will be maintained in all phases for DF schemes, where  $\mathcal{A}_r[i] = 1/\sqrt{N_{\text{asub}}}\mathbf{I}_{N_{\text{ar}}N_r}$  when TDS is employed, and  $\mathcal{A}_r[i] = 1/\sqrt{N_{\text{ar}}N_r}\mathbf{I}_{N_{\text{ar}}N_r}$  for standard cooperative transmission. For AF, the transmit power of the  $m$ th antenna at the  $n$ th relay when TDS is employed is given by

$$\mathbf{A}_{r_n, m}[i] \frac{1}{\sqrt{N_{\text{asub}}\mathbf{H}_{\text{sr}_n, m}[i]\mathbf{H}_{\text{sr}_n, m}^H[i] + \sigma_{\text{sr}}^2}} \quad (59)$$

where  $\mathbf{H}_{\text{sr}_n, m}$  denotes the  $m$ th row of the matrix  $\mathbf{H}_{\text{sr}_n}$ . Equation (59) therefore ensures  $E[\mathcal{A}_r^H[i]\mathcal{A}_r[i]] = 1$ . For standard cooperative transmission,  $N_{\text{asub}}$  is replaced with  $N_{\text{ar}}$ , and to provide CSI, RLS channel estimation will be used [33], [36], [37]. The RLS variables  $\mathbf{P}_{\hat{\mathcal{H}}_{\text{rd}}}$ ,  $\mathbf{P}_{\hat{\mathbf{H}}_{\text{sr}_n}}$ , and  $\mathbf{P}_{\hat{\mathbf{H}}_{\text{sd}}}$  are initialized as identity matrices and  $\lambda$ , and the exponential forgetting factor

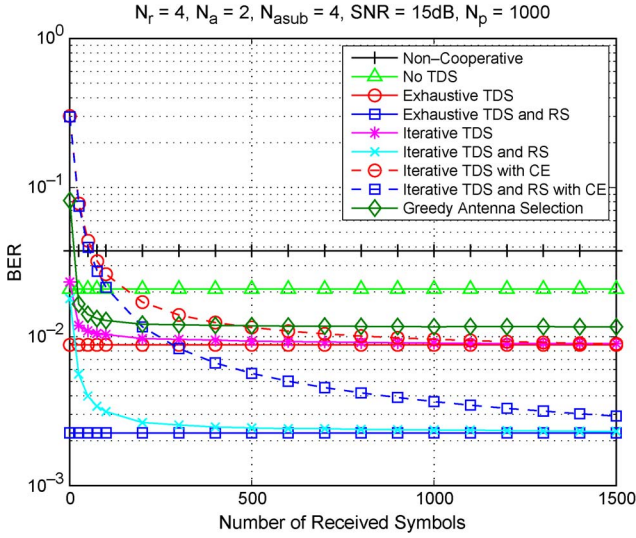

Fig. 5. BER performance versus the number of received symbols for the proposed schemes with full and estimated CSI and optimal linear receivers.

is 0.9. The initial values of  $\hat{\mathcal{H}}_{rd}$ ,  $\hat{\mathbf{H}}_{sr,n}$ , and  $\hat{\mathbf{H}}_{sd}$  are zero matrices. Throughout all simulations,  $N_{as} = N_{ar} = N_{ad} = N_a$ , where  $N_a$  is specified in each plot. Each simulation is averaged over  $N_p$  packets, where  $N_p$  is specified in each plot, and the coherence time is equal to or greater than the period of the packets.

Fig. 5 shows the BER performance versus the number of received symbols for the proposed schemes and the existing GAS method. For the RS schemes, a single relay is removed, and the estimated CSI is used for optimal linear MMSE reception at all nodes. The performance of the TDS schemes exceeds that of the standard cooperative system, and GAS and RS further improve the performance in terms of convergence and steady state. The performance improvement over GAS highlights the drawback of its restricted antenna selection procedure and the resulting low probability that it will converge to the exhaustive solution. The proposed schemes do not suffer from such a restrictive antenna selection procedure and therefore possess a clear advantage of GAS. The improvement brought about by RS indicates a decrease in the likelihood of channel mismatch between the first and second phases and confirms the improvement in convergence performance obtained by refining and reducing the cardinality of the set over which the TDS operates. Finally, the behavior of the CE schemes indicates that TDS, RS, and CE jointly operate correctly and allow the convergence to the exhaustive solution if an appropriate value of  $\lambda$  is chosen.

The BER performance versus SNR of the proposed optimal linear MMSE-based algorithms is shown in Fig. 6. The steeper gradient of the proposed schemes indicates that increased diversity has been achieved by the RS schemes at the SNR of interest, which are gains that increase when  $N_{rem} = 2$ . Improved interference mitigation is also obtained as evidenced by the shifting of the TDS plot compared with the standard system. In general, the BER performance of the iterative scheme closely matches the exhaustive performance after 500 iterations; however, there is an increasing discrepancy for the schemes with  $N_{rem} = 2$  as the SNR increases. This is partially accounted for by the lower BER but is also explained by the increased

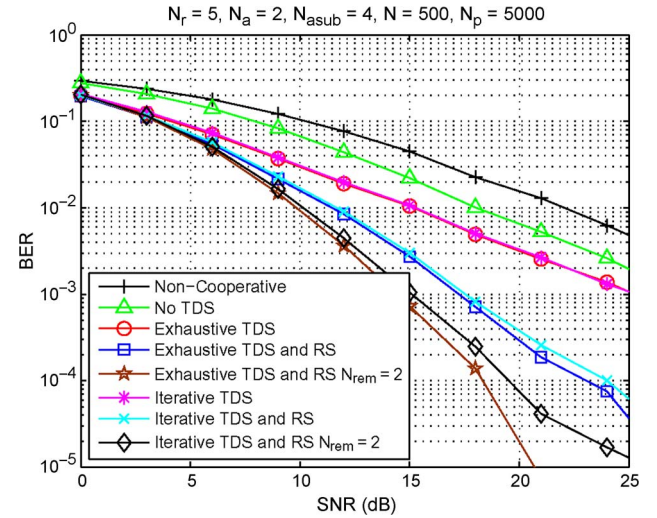

Fig. 6. BER performance versus SNR for the proposed schemes with optimal linear receivers and  $N_{rem} = 1, 2$ .

size of  $\Omega_R$  and the increased time the DSA takes to converge to the optimal  $\Omega_R$ . This results in the TDS portion of the algorithm not operating on the optimal  $\hat{\Omega}_T$  for a significant number of initial iterations and therefore increasing the BER convergence time. The diminishing returns associated with increasing  $N_{rem}$  are also evident from Fig. 6. This is due to the worst performing relaying introducing the highest number of errors, and therefore, the removal of this relay will result in the most significant increase in performance. The aforementioned factors highlight the importance of the choice of  $N_{rem}$  relative to  $N_R$ . Too small a value and a near-optimal BER value will not be achieved because poorly performing relays are not removed from consideration by TDS, but too large a value will result in slow convergence of the RS algorithm and overly restrict the pairing of first- and second-phase channels that TDS with RS achieves. Consequently, the choice of  $N_{rem}$  is similar to the choice of a step size in a stochastic gradient algorithm in as much that it is a tradeoff between convergence and steady-state performance. The choice of  $N_{asub}$  also requires careful consideration. Primarily,  $N_{asub}$  must be chosen so that sufficient diversity is available in the system; however, the effect of  $N_{asub}$  on the cardinality of  $\hat{\Omega}_T$  must also be taken into consideration if an extended convergence period is to be avoided.

An important aspect of cooperative MIMO systems and transmission strategies is their performance in the presence of correlated channels. Fig. 7 shows the performance of the optimal linear MMSE-based schemes over the correlated channels specified in Section VIII-A. Improved interference mitigation and diversity have been achieved by the proposed TDS with RS scheme, and no significant convergence problems are evident. However, as expected, the performance has been degraded by correlated channels compared to the results in Fig. 6, which are based on uncorrelated channels.

The effect of introducing SIC based on optimal linear MMSE reception is illustrated in Fig. 8. The advantage in interference suppression is evident from the shifted plots, but there are also diversity gains when RS is considered. The gains of introducing RS when SIC is utilized are substantial and exceed that of

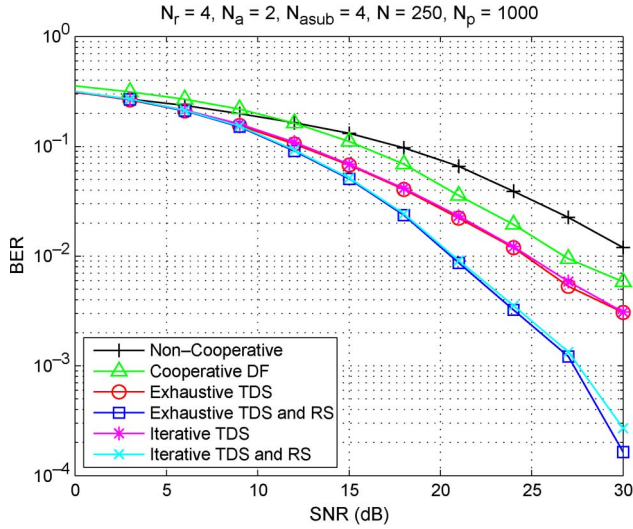

Fig. 7. BER performance versus SNR for the proposed schemes with optimal linear receivers when operating over correlated channels.

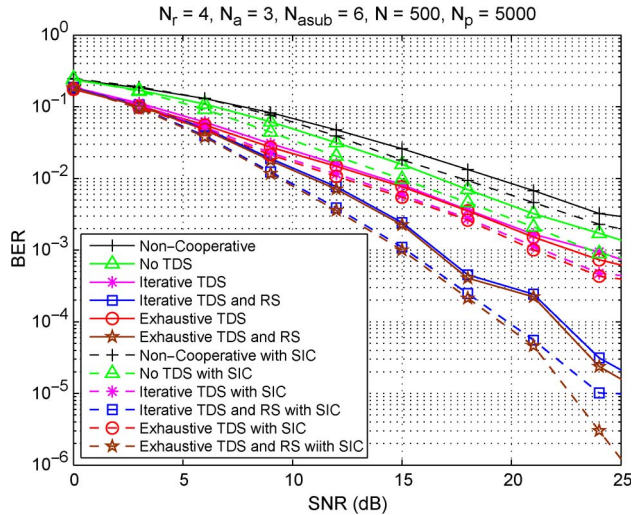

Fig. 8. BER performance versus SNR for the proposed schemes with SIC.

introducing RS when SIC is not used. This can be attributed to the decrease in probability that different symbols have been transmitted from the active relays that RS brings about, thus reducing the likelihood that the identical transmit symbol assumption in Section V-B is violated.

Fig. 9 presents the BER performance versus the number of received symbols for TDS and TDS with RS when joint adaptive linear MMSE reception is used at all nodes. The rate of convergence of both iterative algorithms has been slowed considerably due to the convergence of the receive filters and their ensemble error, as well as because of the challenges of several adaptive schemes operating in parallel. The TDS algorithm converges to its optimal value, but when RS is introduced, convergence issues arise. This is due to the convergence of the receivers at the relay nodes and the resulting initial iterations of the RS algorithm that operate on nonoptimal decoding error information.

Fig. 10 illustrates the performance of the proposed iterative schemes when implemented in an AF system. Both of the

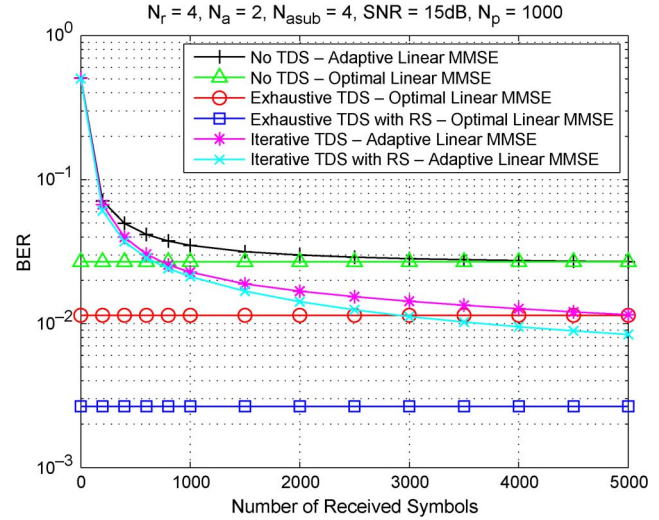

Fig. 9. BER performance versus the number of received symbols for proposed schemes with joint adaptive linear MMSE receive filters.

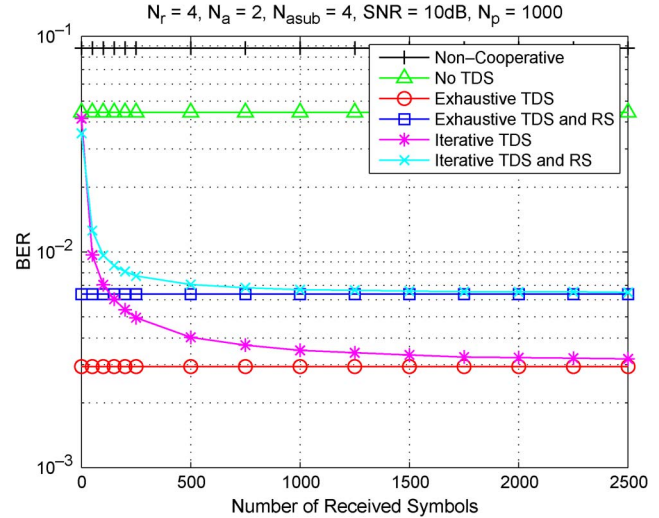

Fig. 10. BER performance versus the number of received symbols for the proposed schemes in an AF system with optimum linear receivers.

iterative schemes converge to their optimal exhaustive counterparts, and as expected, the TDS and RS schemes display increased rates of convergence compared with TDS alone. However, RS does not bring about an improvement in steady state performance as in DF systems. This results from the use of branch SNR as secondary RS criteria because MSE data are not available from the relays. Therefore, integration with the MSE-based TDS at the destination is not as complete.

In previous simulations, the feedback and feedforward channels are assumed error free, but in reality, this assumption is likely to breakdown. Fig. 11 gives the BER performance versus the probability of error in each individual feedback and feedforward bit when no error coding and correction are employed and a 2-bit quantization is used for the MSE forwarding. The TDS and the TDS with RS schemes are compared when optimal linear receivers with full backward CSI are used at all nodes. Both schemes provide improved performance over the noncooperative system up until the probability of error reaches  $\approx 0.1$ , and their performance converges. At this point, 57% of

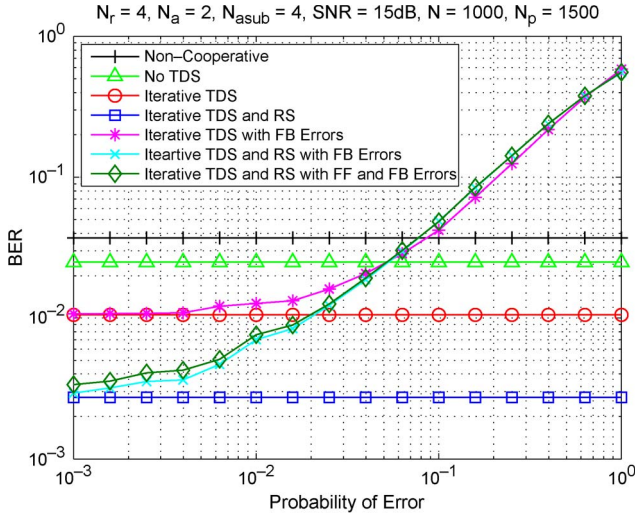

Fig. 11. BER performance versus the probability of feedback errors for the proposed schemes with optimal linear receivers.

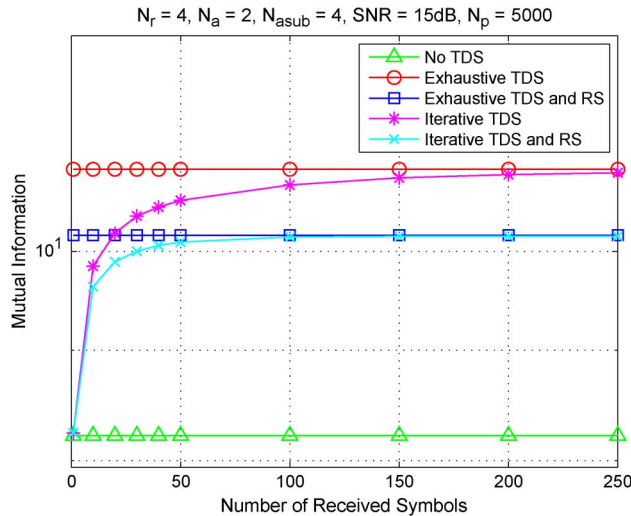

Fig. 12. MI performance versus the number of received symbols for the proposed schemes.

the  $N_a N_r$  feedback bit packets have at least one error. The performance degradation is due to the nonoptimal second-phase channels being utilized, incorrect total transmit power, and incorrect values used in the calculation of the MMSE receiver at the destination node. The effect on system performance of errors and quantization in the forwarded MSE is extremely small and indicates that the RS process is highly robust and requires only very coarse quantization.

Fig. 12 gives the MI of the proposed schemes versus the number of iterations of the DSA. Both schemes achieve gains over the standard system, but RS results in a small performance loss compared with the TDS scheme. This is due to the MI optimization given by (39) not taking into account the MI of the first phase because of the inherent separation between phases in DF systems. However, the TDS with RS scheme has lower complexity and increased speed of convergence compared to TDS alone due to the refined set  $\hat{\Omega}_T$  and its lower cardinality. Additionally, when utilizing RS, the probability of

the MI/capacity of the first phase being unable to satisfy that of the second phase is reduced.

### A. Correlated Channels

In practical cooperative MIMO systems, the channels between antennas pairs are spatially correlated due to the close proximity of the antennas at the transmitting and receiving nodes. Therefore, it is important to assess the impact of the correlated channels on performance.

Generation of correlated channels in this paper is performed using the intelligent multielement transmit and receive antenna model in combination with a power azimuth spectrum (PAS) model [34], [38]. Spatial correlation matrices are generated for each antenna array of the base station ( $\mathbf{R}_{BS}$ ) and mobile station ( $\mathbf{R}_{MS}$ ), and the overall correlation matrices for the uplink and downlinks are, respectively, given by

$$\begin{aligned} \mathbf{R}_{UP} &= \mathbf{R}_{MS} \otimes \mathbf{R}_{BS} \\ \mathbf{R}_{DN} &= \mathbf{R}_{BS} \otimes \mathbf{R}_{MS} \end{aligned} \quad (60)$$

where  $\otimes$  represents the Kronecker product. We apply the proposed schemes to a macrocell environment where the PAS is given by a truncated Laplacian distribution with angle spread (AS) =  $5^\circ$  and AS =  $10^\circ$  for the mobile station and base station, respectively. A single arrival cluster is assumed for all nodes, and the angles of arrival for the mobile and base station are given by  $67.5^\circ$  and  $20^\circ$ , respectively. The antenna spacing at all nodes is  $0.5\lambda$ , where  $\lambda$  denotes the system wavelength.

## IX. CONCLUSION

We have presented TDS and RS methods based on DSA for multirelay cooperative MIMO systems, where RS improves the performance of conventional TDS. Hybrid continuous-discrete MMSE and MI optimization problems have been formed, and a framework to solve them has been developed. The resulting joint TDS with RS DSA schemes have been shown to operate well with optimal receivers, converge in parallel with low-complexity linear adaptive MMSE receivers, exceed the performance of GAS, and, in the majority of scenarios, converge to the optimal solution. Increased diversity and improved interference suppression have been shown to be obtained by the proposed schemes, and full algorithmic implementations have then been given to provide designers with the tools to significantly improve the performance of cooperative MIMO systems.

## REFERENCES

- [1] A. Scaglione, D. L. Goeckel, and J. N. Laneman, "Cooperative communications in mobile ad hoc networks," *IEEE Signal Process. Mag.*, vol. 23, no. 5, pp. 18–29, Sep. 2006.
- [2] Y. Fan and J. Thompson, "MIMO configurations for relay channels: Theory and practice," *IEEE Trans. Wireless Commun.*, vol. 6, no. 5, pp. 1774–1786, May 2007.
- [3] S. W. Peters, A. Y. Panah, K. T. Truong, and R. W. Heath, "Relay architectures for 3GPP LTE-advanced," *EURASIP J. Wireless Commun. Netw.*, vol. 2009, p. 618 787, 2009.
- [4] Z. Fang, Y. Hua, and J. C. Koshy, "Joint source and relay optimization for a non-regenerative MIMO relay," in *Proc. 4th IEEE Workshop Sens. Array Multichannel Process.*, Waltham, MA, Jul. 2006, pp. 239–243.

- [5] I. Berenguer, X. Wang, and V. Krishnamurthy, "Adaptive MIMO antenna selection via discrete stochastic optimization," *IEEE Trans. Signal Process.*, vol. 53, no. 11, pp. 4315–4329, Nov. 2005.
- [6] J. N. Laneman, D. N. C. Tse, and G. Wornell, "Cooperative diversity in wireless networks: Efficient protocols and outage behaviour," *IEEE Trans. Inf. Theory*, vol. 50, no. 12, pp. 3062–3080, Dec. 2004.
- [7] A. Nosratinia, T. E. Hunter, and A. Hedayat, "Cooperative communications in wireless networks," *IEEE Commun. Mag.*, vol. 42, no. 10, pp. 74–80, Oct. 2004.
- [8] V. Stankovic, A. Host-Madsen, and Z. Xiong, "Cooperative communications in wireless networks," *IEEE Signal Process. Mag.*, vol. 23, no. 5, pp. 37–49, Sep. 2006.
- [9] M. A. Torabi and J. Frigon, "Semi-orthogonal relay selection and beamforming for amplify-and-forward MIMO relay channels," in *Proc. IEEE Wireless Commun. Netw. Conf.*, Las Vegas, NV, Mar. 2008, pp. 48–53.
- [10] S. W. Peters and R. Heath, "Nonregenerative MIMO relaying with optimal transmit antenna selection," *IEEE Signal Process. Lett.*, vol. 15, pp. 421–424, 2008.
- [11] G. J. Foschini, "Layered space-time architecture for wireless communication in a fading environment when using multiple antennas," *Bell Labs. Tech. J.*, vol. 1, no. 2, pp. 41–59, Autumn 1996.
- [12] H. Zhang, H. Dai, and B. L. Hughes, "Analysis on the diversity-multiplexing tradeoff for ordered MIMO SIC receivers," *IEEE Trans. Commun.*, vol. 57, no. 1, pp. 125–133, Jan. 2009.
- [13] R. Fa and R. C. de Lamare, "Multi-branch successive interference cancellation for MIMO spatial multiplexing systems: Design, analysis and adaptive implementation," *IET Commun.*, vol. 5, no. 4, pp. 484–494, May 2011.
- [14] P. Li, R. C. de Lamare, and R. Fa, "Multiple feedback successive interference cancellation detection for multiuser MIMO systems," *IEEE Trans. Wireless Commun.*, vol. 10, no. 8, pp. 2434–2439, Aug. 2011.
- [15] R. C. de Lamare and R. Sampaio-Neto, "Minimum mean squared error iterative successive parallel arbitrated decision feedback detectors for DS-CDMA systems," *IEEE Trans. Commun.*, vol. 56, no. 5, pp. 778–789, May 2008.
- [16] R. C. de Lamare, R. Sampaio-Neto, and A. Hjrungnes, "Joint iterative interference cancellation and parameter estimation for CDMA systems," *IEEE Commun. Lett.*, vol. 11, no. 12, pp. 916–918, Dec. 2007.
- [17] Y. Cai and R. C. de Lamare, "Adaptive space-time decision feedback detectors with multiple feedback cancellation," *IEEE Trans. Veh. Technol.*, vol. 58, no. 8, pp. 4129–4140, Oct. 2009.
- [18] Y. Cai, D. le Ruyet, and D. Roviras, "Joint interference suppression and power allocation techniques for multiuser multiantenna relay broadcast systems," in *Proc. Int. Symp. Wireless Commun. Syst.*, York, U.K., Sep. 2010, pp. 265–269.
- [19] R. C. de Lamare, "Joint iterative power allocation and interference suppression algorithms for cooperative spread spectrum networks," in *Proc. Int. Conf. Acoust., Speech Signal Process.*, Dallas, TX, Mar. 2010, pp. 3178–3181.
- [20] R. C. de Lamare and R. Sampaio-Neto, "Adaptive interference suppression for CDMA based on Interpolated FIR filters in multipath channels," *IEEE Trans. Veh. Technol.*, vol. 56, no. 5, pp. 2457–2474, Sep. 2007.
- [21] R. C. de Lamare and R. Diniz, "Set-membership adaptive algorithms based on time-varying error bounds for CDMA interference suppression," *IEEE Trans. Veh. Technol.*, vol. 58, no. 2, pp. 644–654, Feb. 2009.
- [22] M. Ding, S. Liu, H. Luo, and W. Chen, "MMSE based greedy antenna selection scheme for AF MIMO relay systems," *IEEE Signal Process. Lett.*, vol. 17, no. 5, pp. 433–436, May 2010.
- [23] I. Bahceci, T. M. Duman, and Y. Altunbasak, "Antenna selection for multiple-antenna transmission systems: Performance analysis and code construction," *IEEE Trans. Inf. Theory*, vol. 49, no. 10, pp. 2669–2681, Oct. 2003.
- [24] S. Chen, W. Wang, X. Zhang, and D. Zhao, "Performance of amplify-and-forward MIMO relay channels with transmit antenna selection and maximal-ratio combining," in *Proc. IEEE Wireless Commun. Netw. Conf.*, Budapest, Hungary, Apr. 2009, pp. 1–6.
- [25] B. C. Lim, W. A. Krzymien, and C. Schlegel, "Efficient sum rate maximization and resource allocation in block-diagonalized space-division multiplexing," *IEEE Trans. Veh. Technol.*, vol. 58, no. 1, pp. 478–484, Jan. 2009.
- [26] F.-S. Tseng and W.-R. Wu, "MMSE-SIC transceiver design in amplify-and-forward MIMO relay systems," in *Proc. IEEE Veh. Technol. Conf.*, Taipei, Taiwan, May 2010, pp. 1–5.
- [27] H. S. Ryu, C. G. Kang, and D. S. Kwon, "Transmission protocol for cooperative MIMO with full rate: Design and analysis," in *Proc. IEEE Veh. Technol. Conf.*, Dublin, Ireland, May 2007, pp. 934–938.
- [28] P. Clarke and R. C. de Lamare, "MMSE transmit diversity selection for multi-relay cooperative MIMO systems using discrete stochastic gradient algorithms," in *Proc. IEEE 17th Int. Conf. Digit. Signal Process.*, Corfu, Greece, Jul. 2011, pp. 1–6.
- [29] P. Clarke and R. C. de Lamare, "Joint transmit diversity optimization and relay selection for multi-relay cooperative MIMO systems using discrete stochastic algorithms," *IEEE Commun. Lett.*, vol. 15, no. 10, pp. 1035–1037, Oct. 2011.
- [30] S. Andrados, "A global search method for discrete stochastic optimization," *SIAM J. Opt.*, vol. 6, no. 2, pp. 513–530, May 1996.
- [31] L. Zheng and D. N. C. Tse, "Diversity and multiplexing: A fundamental tradeoff in multiple-antenna channels," *IEEE Trans. Inf. Theory*, vol. 49, no. 5, pp. 1073–1096, May 2003.
- [32] A. Hedayat and A. Nosratinia, "Outage and diversity of linear receivers in flat fading MIMO channels," *IEEE Trans. Signal Process.*, vol. 55, no. 12, pp. 5868–5873, Dec. 2007.
- [33] S. Haykin, *Adaptive Filter Theory*, 4th ed. Englewood Cliffs, NJ: Prentice-Hall, 2002.
- [34] Y. S. Cho, J. Kim, W. Y. Yang, and C. G. Kang, *MIMO-OFDM Wireless Communications With MATLAB*. Hoboken, NJ: Wiley, Oct. 2010.
- [35] I. Telatar, "Capacity of multi-antenna Gaussian channels," *Eur. Trans. Telecommun.*, vol. 10, no. 6, pp. 585–595, Nov. 1999.
- [36] P. Lioliou, M. Viberg, and M. Coldrey, "Performance analysis of relay channel estimation," in *Proc. IEEE Asilomar Conf. Signals, Syst. Comput.*, Nov. 2009, pp. 1533–1537.
- [37] P. Lioliou and M. Viberg, "Least-squares based channel estimation for MIMO relays," in *Proc. Int. Workshop Smart Antennas*, Darmstadt, Germany, Feb. 2008, pp. 90–95.
- [38] L. Schumacher, K. I. Pedersen, and P. Mogensen, "From antenna spacings to theoretical capacities—Guidelines for simulating MIMO systems," in *Proc. IEEE Int. Symp. Pers., Indoor Mobile Radio Commun.*, Lisbon, Portugal, Sep. 2002, pp. 587–592.
- [39] R. C. de Lamare and R. Sampaio-Neto, "Adaptive reduced-rank MMSE filtering with interpolated FIR filters and adaptive interpolators," *IEEE Signal Process. Lett.*, vol. 12, no. 3, pp. 177–180, Mar. 2005.
- [40] M. L. Honig and J. S. Goldstein, "Adaptive reduced-rank interference suppression based on the multistage Wiener filter," *IEEE Trans. Commun.*, vol. 50, no. 6, pp. 986–994, Jun. 2002.
- [41] R. C. de Lamare and R. Sampaio-Neto, "Reduced-rank adaptive filtering based on joint iterative optimization of adaptive filters," *IEEE Signal Process. Lett.*, vol. 14, no. 12, pp. 980–983, Dec. 2007.
- [42] H. Qian and S. N. Batalama, "Data record-based criteria for the selection of an auxiliary vector estimator of the MMSE/MVDR filter," *IEEE Trans. Commun.*, vol. 51, no. 10, pp. 1700–1708, Oct. 2003.
- [43] R. C. de Lamare and R. Sampaio-Neto, "Reduced-rank space-time adaptive interference suppression with joint iterative least squares algorithms for spread-spectrum systems," *IEEE Trans. Veh. Technol.*, vol. 59, no. 3, pp. 1217–1228, Mar. 2010.
- [44] R. C. de Lamare and R. Sampaio-Neto, "Adaptive reduced-rank equalization algorithms based on alternating optimization design techniques for MIMO systems," *IEEE Trans. Veh. Technol.*, vol. 60, no. 6, pp. 2482–2494, Jul. 2011.

**Patrick Clarke** (S'09) received the M.Eng. degree in electronic engineering from the University of York, York, U.K., where he is currently working toward the Ph.D. degree with the communications research group.

His research interests are adaptive signal processing and cooperative communications.

**Rodrigo C. de Lamare** (S'99–M'04–SM'10) received the Diploma degree in electronic engineering from the Federal University of Rio de Janeiro, Rio de Janeiro, Brazil, in 1998 and the M.Sc. and Ph.D. degrees in electrical engineering from the Pontifical Catholic University of Rio de Janeiro, in 2001 and 2004, respectively.

Since January 2006, he has been with the Communications Research Group, Department of Electronics, University of York, York, U.K., where he is currently a Lecturer in communications engineering. His research interests include communications and signal processing. He has published more than 200 papers in refereed journals and conferences in these areas.

Dr. de Lamare served as the General Chair of the Seventh IEEE International Symposium on Wireless Communications Systems, which was held in York, in September 2010. He serves as Associate Editor for the *EURASIP Journal on Wireless Communications and Networking*.

# Transmit Diversity and Relay Selection Algorithms for Multirelay Cooperative MIMO Systems

Patrick Clarke, *Student Member, IEEE*, and Rodrigo C. de Lamare, *Senior Member, IEEE*

**Abstract**—In this paper, we propose a set of joint transmit diversity selection (TDS) and relay selection (RS) algorithms based on discrete iterative stochastic optimization for the uplink of cooperative multiple-input–multiple-output (MIMO) systems. Decode-and-forward (DF) and amplify-and-forward (AF) multirelay systems with linear minimum mean square error (MSE), successive interference cancelation, and adaptive reception are considered. The problems of TDS and RS are expressed as MSE and mutual information (MI) joint discrete optimization problems and solved using iterative discrete stochastic algorithms. Such an approach circumvents the need for exhaustive searching and results in a range of procedures with low complexity and increased speed of convergence that can track the optimal selection over an estimated channel. The proposed schemes are analyzed in terms of their complexity, convergence, and diversity benefits and are shown to be both stable and computationally efficient. Their performance is then evaluated via MSE, MI, and bit error rate comparisons and shown to outperform conventional cooperative transmission and, in the majority of scenarios, match that of the optimal exhaustive solution.

**Index Terms**—Cooperative systems, discrete stochastic optimization, minimum mean square error (MMSE) receivers, multiple-input–multiple-output (MIMO) relaying, relay selection (RS), transmit diversity (TD).

## I. INTRODUCTION

COOPERATIVE multiple-input–multiple-output (MIMO) networks have received significant attention in the recent research literature due to their spatial diversity gain, multiplexing gain, robustness, low power, and high capacity. These desirable characteristics make such systems well suited to future mobile network applications where there is a requirement for extended coverage, increased data rates, and enhanced quality of service while minimizing infrastructure investment. Consequently, cooperative MIMO techniques have been incorporated into future mobile protocols [1]–[8]. Although still in their infancy, promising results and techniques for cooperative MIMO systems have been published, predominantly focusing on cooperation protocols, routing, information-theoretic limits, and diversity maximization [2]. The decode-and-forward (DF) and amplify-and-forward (AF) protocols both offer added degrees of freedom, which, when effectively exploited, can lead to

significant performance gains. Cooperative MIMO systems also enable the use of transmit diversity (TD) selection and relay optimization to improve performance and reduce the number of relays burdened with retransmission of the signal. Transmit diversity selection (TDS) and relay selection (RS) can be viewed as suboptimal variants of beamforming, where transmit powers are constrained to discrete values of 1 and 0. However, a trade-off exists between this suboptimality and the reduced feedback requirements resulting from the 1-bit quantization [9], [10]. The multiplexing gain resulting from MIMO systems is an attractive feature, but there is an associated increase in interference from multistream transmission. When channel state information (CSI) is available at the receiver, this interference can be mitigated by the use of successive interference cancelation (SIC) and equivalent techniques, such as the vertical Bell-Labs layered space–time and multibranch implementations [11]–[15]. If CSI is not available, adaptive interference suppression and reception provides an alternative method to mitigate this interference at significantly lower computational expense [18]–[21]. Previous works [22]–[29] that have addressed antenna selection and RS considered various approaches to obtain increased performance and low complexity. A number of works dealing with antenna selection have been reported in [22]–[25], where the criteria ranged from the minimum mean square error (MMSE) [22] to the maximum signal-to-noise ratio [23], [24] and the sum rate [25]. Techniques for cooperative interference suppression have been reported in [26]–[28].

In this paper, the problem of low-complexity optimization of TDS with the aid of RS is addressed for a cooperative MIMO system, where a variety of MMSE-based reception techniques are used. The finite nature of TDS makes it a discrete optimization problem where conventional continuous iterative methods are unsuitable. Although solvable with an exhaustive search, this constitutes a highly complex solution and is therefore inappropriate for practical implementation. Consequently, a discrete stochastic method first proposed in [30] is introduced as an alternative low-complexity method to arrive at the optimum TD. However, convergence is dependent upon the size of the set of solutions, and this therefore acts as a limiting factor on the performance of an algorithm. Furthermore, the potential for inaccurate reception at the relays leads to complications and performance implications for the relaying protocol. To address these issues, we introduce a technique termed RS that eliminates the most poorly performing relays from consideration. This leads to a reduction in the cardinality and an increase in the quality of the solution set. To formalize this approach, we develop a joint TDS and RS framework and present a number of discrete iterative algorithms based on the

Manuscript received June 15, 2011; revised November 3, 2011; accepted December 27, 2011. The review of this paper was coordinated by Prof. H. H. Nguyen.

The authors are with the Communications Research Group, Department of Electronics, University of York, YO10 5DD York, U.K. (e-mail: pjc500@ohm.york.ac.uk; rcd1500@ohm.york.ac.uk).

Color versions of one or more of the figures in this paper are available online at <http://ieeexplore.ieee.org>.

Digital Object Identifier 10.1109/TVT.2012.2186619



mean square error (MSE) and mutual information (MI) criteria. These schemes are shown to converge to the exhaustive solution at low computational expense and also operate effectively when recursive least square (RLS) channel estimation is introduced to provide the CSI required for MSE calculation and linear and nonlinear MMSE reception. To illustrate the versatility of the proposed algorithms and their ability to jointly operate with continuous algorithms, they are also applied to low-complexity continuous adaptive interference suppression. We analyze the complexity, convergence, and diversity gains of the proposed algorithms and implement them in a multirelay cooperative MIMO system. Comparisons are drawn against optimal exhaustive solutions, standard cooperative implementations, and the existing greedy antenna selection (GAS) method [22].

The rest of this paper is organized as follows. Section II gives the system and data models, and Section III presents the reception techniques used throughout this paper. Sections IV and V detail the problems that face multirelay cooperative MIMO systems, the corresponding linear and nonlinear MMSE and MI optimization problems, and the framework for their solution. The proposed discrete iterative algorithms that address the optimization problems are given in Section VI. Section VII presents the analysis of and an investigation into the complexity, convergence, diversity, and feedback properties of the proposed algorithms. The performance of the proposed algorithms, along with comparisons against standard cooperative and non-cooperative methods, is then given in Section VIII. This paper is drawn to a close by the concluding remarks given in Section IX.

*Notation:* Throughout this paper, bold upper- and lowercase letters represent matrices and vectors, respectively. The complex conjugate, complex conjugate transpose (Hermitian), inverse, and transpose operations are denoted by  $(\cdot)^*$ ,  $(\cdot)^H$ ,  $(\cdot)^{-1}$ , and  $(\cdot)^T$ , respectively. The trace of a matrix is represented by  $\text{trace}(\cdot)$ , and  $\mathbf{I}_m$  represents an  $m \times m$  identity matrix. Block structures made up of 0s will be represented by  $\mathbf{0}_{M \times D}$ , where  $M$  and  $D$  specify the dimensions of the structure. Estimated values are denoted by the addition of a hat ( $\hat{\cdot}$ ), stacked vectors by the addition of a bar ( $\bar{\cdot}$ ),  $|\cdot|$  represents the cardinality of a set, and  $\text{diag}(\cdot)$  represents a diagonal matrix with the argument's elements across the main diagonal.

## II. SYSTEM AND DATA MODEL

The cooperative network considered in this paper is a two-phase system where the direct path is nonnegligible and no intersymbol interference is assumed. All relays are half-duplex, and MMSE interference suppression and symbol estimation are performed at all decoding nodes. Single source and destination nodes are separated by  $N_r$  intermediate relay nodes, where the channel of each antenna pair is represented by a complex gain. The direct path has a gain that is a fraction of the indirect paths to reflect the increased geographical distance and shadowing involved. The source and destination nodes each have  $N_{as}$  forward and  $N_{ad}$  backward antennas, respectively, and the relay nodes have  $N_{ar}$  forward and backward antennas.  $N_{as}$  data streams are transmitted in the system, and each is allocated to the correspondingly numbered antenna at the source node.

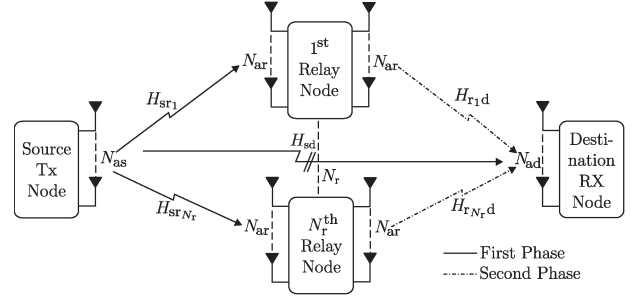

Fig. 1. MIMO multirelay system model.

Data are transmitted in  $N$  symbol packets, and during the first phase, transmission from the source to the relay and destination nodes takes place. The second phase then consists of decoding, power normalization, and forwarding for the DF protocol and a simple power normalization and retransmission for the AF protocol. All channels are assumed uncorrelated, unless otherwise specified, with frequency-flat block fading, where the coherence time is equal to the duration of the  $N$ -symbol packet. The total average transmit power in each phase is maintained at unity and equally distributed between the active antennas. The maximum spatial multiplexing gain and diversity advantage simultaneously available in the system are  $r^* = N_{as}$  and  $d^* = N_{ad}(1 + (N_r N_{ar}/N_{as}))$ , respectively [31], [32]. An outline system model is given in Fig. 1.

### A. Decode-and-Forward

The received signals of the first phase at the destination and  $n$ th relay for the  $i$ th symbol are respectively given by

$$\mathbf{r}_{sd}[i] = \mathbf{H}_{sd}[i] \mathbf{A}_s[i] \mathbf{T}_s[i] \mathbf{s}[i] + \boldsymbol{\eta}_{sd}[i] \quad (1)$$

$$\mathbf{r}_{sr_n}[i] = \mathbf{H}_{sr_n}[i] \mathbf{A}_s[i] \mathbf{T}_s[i] \mathbf{s}[i] + \boldsymbol{\eta}_{sr_n}[i]. \quad (2)$$

The structures  $\mathbf{H}_{sd}$  and  $\mathbf{H}_{sr_n}$  are the  $N_{as} \times N_{ad}$  source–destination and  $N_{as} \times N_{ar}$  source– $n$ th relay channel matrices, respectively. The quantities  $\boldsymbol{\eta}_{sd}$  and  $\boldsymbol{\eta}_{sr_n}$  are the  $N_{ad} \times 1$  and  $N_{ar} \times 1$  vectors of zero mean additive white Gaussian noise at the destination and  $n$ th relay, respectively, whose variances are  $\sigma_{sd}^2$  and  $\sigma_{sr_n}^2$  and autocorrelation matrices  $\sigma_{sd}^2 \mathbf{I}_{N_{ad}}$  and  $\sigma_{sr_n}^2 \mathbf{I}_{N_{sr_n}}$ . The source's  $N_{as} \times 1$  transmit data vector is denoted by  $\mathbf{s}$ , and  $\mathbf{A}_s$  is the diagonal source transmit power allocation matrix that acts to normalize the average total transmit power of the first phase to unity assuming that the modulation scheme is also power normalized to 1. Finally,  $\mathbf{T}_s$  is a diagonal  $N_{as} \times N_{as}$  source TDS matrix, where a 1 on each element of the main diagonal specifies whether the correspondingly numbered antenna is active. Consequently, to maintain the maximum multiplexing gain under the described protocol, all source antennas are required; therefore,  $\mathbf{T}_s[i] = \mathbf{I}_{N_{as}}$  throughout this paper.

At the  $n$ th relay, the output of the reception and interference suppression procedure is denoted  $\mathbf{z}_{r_n}[i]$ , and the decoded symbol vector is given by

$$\hat{\mathbf{s}}_{r_n}[i] = Q(\mathbf{z}_{r_n}[i]) \quad (3)$$

where  $Q(\cdot)$  is a general quadrature-amplitude-modulation slicer.

The  $N_{\text{ad}} \times 1$  second-phase received signal at the destination is the summation of the  $N_r$  relayed signals, yielding

$$\mathbf{r}_{\text{rd}}[i] = \sum_{n=1}^{N_r} \mathbf{H}_{\text{r}_n, \text{d}}[i] \mathbf{A}_{\text{r}_n}[i] \mathbf{T}_{\text{r}_n}[i] \hat{\mathbf{s}}_{\text{r}_n}[i] + \boldsymbol{\eta}_{\text{rd}}[i] \quad (4)$$

where  $\mathbf{H}_{\text{r}_n, \text{d}}$  is the  $n$ th relay–destination channel matrix, and  $\mathbf{A}_{\text{r}_n}[i]$  is the  $n$ th relay transmit power allocation matrix that ensures the total transmit power of the second phase is unity, i.e.,

$$E \left[ \sum_{j=1}^{N_r} \text{trace} \left( \mathbf{A}_{\text{r}_j}^H[i] \mathbf{A}_{\text{r}_j}[i] \right) \right] = 1.$$

$\mathbf{T}_{\text{r}_n}$  is the TDS matrix of the  $n$ th relay that specifies which of its  $N_{\text{ar}}$  antennas are active.

The summation of (4) can be expressed in a more compact form given by

$$\mathbf{r}_{\text{rd}}[i] = \mathcal{H}_{\text{rd}}[i] \mathcal{A}_{\text{r}}[i] \mathcal{T}_r[i] \hat{\mathbf{s}}[i] + \boldsymbol{\eta}_{\text{rd}}[i] \quad (5)$$

where  $\mathcal{T}_r[i] = \text{diag}[\mathbf{T}_{\text{r}_1}[i] \ \mathbf{T}_{\text{r}_2}[i] \ \dots \ \mathbf{T}_{\text{r}_{N_r}}[i]]$  is the  $N_{\text{ar}} N_r \times N_{\text{ar}} N_r$  compound relay TDS matrix,  $\hat{\mathbf{s}}[i] = [\hat{\mathbf{s}}_{\text{r}_1}^T[i] \ \hat{\mathbf{s}}_{\text{r}_2}^T[i] \ \dots \ \hat{\mathbf{s}}_{\text{r}_{N_r}}^T[i]]^T$ ,  $\mathcal{H}_{\text{rd}}[i] = [\mathbf{H}_{\text{r}_1, \text{d}}[i] \ \mathbf{H}_{\text{r}_2, \text{d}}[i] \ \dots \ \mathbf{H}_{\text{r}_{N_r}, \text{d}}[i]]$  is the  $N_{\text{ad}} \times N_{\text{ar}} N_r$  compound channel matrix, and  $\mathcal{A}_{\text{r}}[i] = \text{diag}[\mathbf{A}_{\text{r}_1}[i] \ \mathbf{A}_{\text{r}_2}[i] \ \dots \ \mathbf{A}_{\text{r}_{N_r}}[i]]$  is the compound power allocation matrix, where  $\text{trace}(\mathcal{A}_{\text{r}}^H[i] \mathcal{A}_{\text{r}}[i]) = 1$ . The final received signal at the destination is then formed by stacking the received signals from the relay and source nodes to give

$$\mathbf{r}_d[i] = \begin{bmatrix} \mathbf{r}_{\text{sd}}[i] \\ \mathbf{r}_{\text{rd}}[i] \end{bmatrix}. \quad (6)$$

### B. Amplify-and-Forward

For the AF protocol, the common approach of compounding the first- and second-phase signals and channels is used [10], resulting in the following expressions for the destination's second-phase received signal:

$$\mathbf{r}_{\text{rd}}[i] = \mathcal{H}_{\text{rd}}[i] \mathcal{A}_{\text{r}}[i] \mathcal{T}_r[i] \bar{\mathbf{r}}_{\text{sr}}[i] + \boldsymbol{\eta}_{\text{rd}} \quad (7)$$

where  $\bar{\mathbf{r}}_{\text{sr}}[i] = [\mathbf{r}_{\text{sr}_1}^T[i] \ \mathbf{r}_{\text{sr}_2}^T[i] \ \dots \ \mathbf{r}_{\text{sr}_{N_r}}^T[i]]^T$  can be interpreted as the AF equivalent of  $\hat{\mathbf{s}}[i]$ . Expanding (7) yields

$$\mathbf{r}_{\text{rd}}[i] = \mathcal{H}_{\text{rd}}[i] \mathcal{A}_{\text{r}}[i] \mathcal{T}_r[i] \mathcal{H}_{\text{sr}}[i] \mathbf{A}_{\text{s}}[i] \mathbf{T}_{\text{s}}[i] \mathbf{s}[i] + \mathcal{H}_{\text{rd}}[i] \mathcal{A}_{\text{r}}[i] \mathcal{T}_r[i] \bar{\boldsymbol{\eta}}_{\text{sr}} + \boldsymbol{\eta}_{\text{rd}} \quad (8)$$

where  $\mathcal{H}_{\text{sr}}[i] = [\mathbf{H}_{\text{sr}_1}^T[i] \ \mathbf{H}_{\text{sr}_2}^T[i] \ \dots \ \mathbf{H}_{\text{sr}_{N_r}}^T[i]]^T$ , and  $\mathcal{A}_{\text{r}}[i]$  normalizes the average transmit power of the second phase based on each relay's receive power. The received signals of the first and second phases can then be stacked as in (6) to give  $\mathbf{r}_d[i]$ .

## III. RECEPTION TECHNIQUES

In cooperative MIMO networks, signal detection and interference suppression are required for the signals given by (2) and (6). In this paper, we focus on MMSE-based reception techniques due to their simplicity, versatility, well-understood characteristics, and ease of extracting performance metrics. In

this section, we introduce MMSE techniques that are already known in the literature but whose application to multirelay cooperative MIMO systems is not widespread [18], [22], [32], [33]. However, although beyond the scope of this paper, it is possible to use more complex and sophisticated nonlinear techniques such as decision feedback and maximum likelihood receivers. We primarily concentrate on the DF protocol, but expressions for reception at the destination node are easily transferred to the AF.

### A. Optimal Linear MMSE Reception

Linear MMSE reception can be achieved with the use of the Wiener filter [33]. The cost functions for the Wiener filter at the  $n$ th relay and the destination are given by

$$\mathbf{W}_{\text{r}_n}^{\text{opt}} = \arg \min_{\mathbf{W}_{\text{r}_n}[i]} E \left\| \mathbf{s}[i] - \underbrace{\mathbf{W}_{\text{r}_n}^H[i] \mathbf{r}_{\text{sr}_n}[i]}_{\mathbf{z}_{\text{r}_n}[i]} \right\|^2 \quad (9)$$

$$\mathbf{W}_d^{\text{opt}} = \arg \min_{\mathbf{W}_d[i]} E \left\| \mathbf{s}[i] - \underbrace{\mathbf{W}_d^H[i] \mathbf{r}_d[i]}_{\mathbf{z}_d[i]} \right\|^2 \quad (10)$$

whose dimensions are  $N_{\text{ar}} \times N_{\text{as}}$  and  $2N_{\text{ad}} \times N_{\text{as}}$ , respectively. These expressions yield the following filters:

$$\mathbf{W}_{\text{sr}_n} = \mathbf{R}_{\text{sr}_n}^{-1} \mathbf{P}_{\text{sr}_n} \quad (11)$$

$$\mathbf{W}_d = \mathbf{R}_d^{-1} \mathbf{P}_d \quad (12)$$

where  $\mathbf{R}_{\text{sr}_n} = E[\mathbf{r}_{\text{sr}_n}[i] \mathbf{r}_{\text{sr}_n}^H[i]]$ ,  $\mathbf{P}_{\text{sr}_n} = E[\mathbf{r}_{\text{sr}_n}[i] \mathbf{s}^H[i]]$ ,  $\mathbf{R}_d = E[\mathbf{r}_d[i] \mathbf{r}_d^H[i]]$ , and  $\mathbf{P}_d = E[\mathbf{r}_d[i] \mathbf{s}^H[i]]$ . The MSEs at the destination and  $n$ th relay are then, respectively, given by

$$\sigma_{\text{s}}^2 - \text{trace}(\mathbf{P}_d^H \mathbf{R}_d^{-1} \mathbf{P}_d) \quad (13)$$

$$\sigma_{\text{s}}^2 - \text{trace}(\mathbf{P}_{\text{sr}_n}^H \mathbf{R}_{\text{sr}_n}^{-1} \mathbf{P}_{\text{sr}_n}) \quad (14)$$

where  $\sigma_{\text{s}}^2 = E[\mathbf{s}^H[i] \mathbf{s}[i]]$ .

### B. Optimal MMSE SIC Reception

Nonlinear reception offers performance advantages in MIMO systems by assisting in the mitigation of the multi-antenna interference; however, this is at the cost of increased complexity. By using MMSE SIC, advantages can be obtained while avoiding the levels of complexity associated with other nonlinear methods such as sphere decoding and full maximum likelihood decoding. The implementation of SIC in MIMO systems has been addressed in previous works, but cooperative DF MIMO systems add an additional layer of complexity to the process due to the two reception phases and multiple independent nodes transmitting simultaneously, [13]–[17]. To perform SIC at the destination, we begin with the destination received vector, where the contribution of the  $l$ th  $-1$  data streams has been removed for the  $l$ th layer of decoding

$$\mathbf{r}_d^l[i] = \begin{bmatrix} \mathbf{r}_{\text{sd}}^l[i] \\ \mathbf{r}_{\text{rd}}^l[i] \end{bmatrix} \quad (15)$$

where

$$\mathbf{r}_{rd}^l[i] = \mathbf{r}_{rd}[i] - \mathcal{H}_{rd}[i] \mathcal{A}_r[i] \mathbf{T}_r[i] \hat{\mathbf{s}}_d^{l-1}[i] \quad (16)$$

$$\mathbf{r}_{sd}^l[i] = \mathbf{r}_{sd}[i] - \mathbf{H}_{sd}[i] \mathbf{A}_s[i] \mathbf{T}_s[i] \hat{\mathbf{s}}_d^{l-1}[i]. \quad (17)$$

The detection and estimation of the  $l$ th data stream at the destination are performed using relayed and direct signals. To avoid auxiliary calculations and minimize complexity, the interference cancellation is unordered and done in a batch process where a single destination symbol estimate is used to generate the cancellation terms from all the relevant source and relay antennas. The estimated symbol interference cancellation vector is given by

$$\hat{\mathbf{s}}_d^l[i] = \begin{bmatrix} \hat{s}_d^l[i] \\ \vdots \\ \hat{s}_d^l[i] \end{bmatrix}_{N_r} \quad (18)$$

where

$$\hat{\mathbf{s}}_d^0[i] = \begin{bmatrix} 0 \\ \vdots \\ 0 \end{bmatrix}_{N_{as}} \quad \text{for } l=0 \quad \hat{\mathbf{s}}_d^l[i] = \begin{bmatrix} \hat{s}_d^1[i] \\ \vdots \\ \hat{s}_d^l[i] \\ \mathbf{0}_{(N_{as}-l) \times 1} \end{bmatrix} \quad \text{for } l=1 \dots N_{as}-1. \quad (19)$$

The destination Wiener filter for the  $l$ th layer is then given by

$$\mathbf{w}_d^l = (\mathbf{R}_d^l)^{-1} \mathbf{p}_d^l \quad (20)$$

where  $\mathbf{R}_d^l = E[\mathbf{r}_d^l[i](\mathbf{r}_d^l[i])^H]$  and  $\mathbf{p}_d^l = E[\mathbf{r}_d^l[i](s^l[i])^*]$  are the associated correlation matrices, and  $s^l[i]$  is the  $l$ th element of the symbol vector  $\mathbf{s}[i]$ . MMSE SIC reception is also undertaken at each relay, where the modified received signal for the  $l$ th layer of decoding at the  $n$ th relay is given by

$$\mathbf{r}_{srn}^l[i] = \mathbf{r}_{srn}[i] - \mathbf{H}_{srn}[i] \mathbf{A}_s[i] \mathbf{T}_s[i] \hat{\mathbf{s}}_{rn}^{l-1}[i] \quad (21)$$

where

$$\hat{\mathbf{s}}_{rn}^0[i] = \begin{bmatrix} 0 \\ \vdots \\ 0 \end{bmatrix}_{N_{as}} \quad \text{for } l=0 \quad \hat{\mathbf{s}}_{rn}^l[i] = \begin{bmatrix} \hat{s}_{rn}^1[i] \\ \vdots \\ \hat{s}_{rn}^l[i] \\ \mathbf{0}_{(N_{as}-l) \times 1} \end{bmatrix} \quad \text{for } l=1 \dots N_{as}-1 \quad (22)$$

form the estimated symbol interference cancellation vector. The associated Wiener filter is then given by

$$\mathbf{w}_{rn}^l = (\mathbf{R}_{rn}^l)^{-1} \mathbf{p}_{rn}^l \quad (23)$$

where  $\mathbf{R}_{rn}^l = E[\mathbf{r}_{rn}^l[i](\mathbf{r}_{rn}^l[i])^H]$  and  $\mathbf{p}_{rn}^l = E[\mathbf{r}_{rn}^l[i](s^l[i])^*]$  are the required correlation matrices. The MSEs resulting from SIC at the relays and destination are, respectively, given by

$$\text{MSE}_{rn} = \sigma_s^2 - \sum_{j=1}^{N_{as}} \left( (\mathbf{P}_{rn}^j)^H (\mathbf{R}_{rn}^j)^{-1} \mathbf{P}_{rn}^j \right) \quad (24)$$

$$\text{MSE}_d = \sigma_s^2 - \sum_{j=1}^{N_{as}} \left( (\mathbf{P}_d^j)^H (\mathbf{R}_d^j)^{-1} \mathbf{P}_d^j \right) \quad (25)$$

where the summation is formed from the MSE contribution of each element of the estimated symbol vector  $\hat{\mathbf{s}}[i]$ , and the required structures are analogous to those utilized in (13).

### C. Iterative Adaptive Linear MMSE Reception

Adaptive reception and interference suppression is a low-complexity and practical alternative to the two previous techniques. By iteratively converging toward the optimal estimation and interference suppression filter, the computational expense can be significantly reduced. The derivation of this approach begins as in Section III-A with an MSE optimization problem given by

$$\mathbf{W}_d^{\text{opt}}[i] = \arg \min_{\mathbf{W}_d[i]} E \left[ \|\mathbf{s}[i] - \mathbf{W}_d^H[i] \mathbf{r}_d[i]\|^2 \right]. \quad (26)$$

However, instead of solving optimally, a stochastic gradient approach is chosen. The gradient is taken with respect to the filter  $\mathbf{W}_d$  and a recursive least mean square (LMS) update equation formed with the aid of a step-size  $\mu$ . This results in

$$\mathbf{W}_d[i+1] = \mathbf{W}_d[i] + \mu_d \mathbf{r}_d[i] \mathbf{e}_d^H[i] \quad (27)$$

where

$$\mathbf{e}_d[i] = \mathbf{s}[i] - \mathbf{W}_d^H[i] \mathbf{r}_d[i] \quad (28)$$

and  $\mathbf{s}[i]$  is provided by a known training sequence or in a decision directed manner. A similar approach is also taken for reception at the relay nodes, resulting in the following LMS update equations:

$$\mathbf{W}_{rn}[i+1] = \mathbf{W}_{rn}[i] + \mu_r \mathbf{r}_{rn}[i] \mathbf{e}_{rn}^H[i] \quad (29)$$

where

$$\mathbf{e}_{rn}[i] = \mathbf{s}[i] - \mathbf{W}_{rn}^H[i] \mathbf{r}_{rn}[i]. \quad (30)$$

Alternatively, a designer can employ more sophisticated estimation algorithms such as reduced-rank techniques [39]–[44].

### D. Mutual Information

Maximization of the enhanced capacity and sum rate that cooperative MIMO networks offer is another important feature of reception techniques in cooperative MIMO systems. In [34] and [35], the formulation of the MI of a conventional MIMO system is studied. Treating the cooperative system considered in this paper in a similar manner, it is possible to arrive at an expression for the MI of the first and second phases. Fundamentally, the MI of a phase is given by the difference between the differential entropy and the conditional differential entropy of the received signal when the transmit data are known. This can be expressed as

$$I_{rn}(\mathbf{s}; \mathbf{r}_{rn}) = H(\mathbf{r}_{rn}) - H(\mathbf{r}_{rn} | \mathbf{s}) \quad (31)$$

$$I_d(\mathbf{s}; \mathbf{r}_d) = H(\mathbf{r}_d) - H(\mathbf{r}_d | \mathbf{s}) \quad (32)$$

for reception at the  $N_r$ th during first phase and reception at the destination during the second phase, respectively. With further

manipulation presented in [34] and [35], the MI of the first and second phases can respectively be expressed as

$$I_{r_n}(\mathbf{s}; \mathbf{r}_{r_n}) = \log_2 \det \left( \mathbf{I}_{N_a} + E \left[ \mathbf{H}_{sr_n}[i] \mathbf{A}_s[i] \mathbf{T}_s[i] \hat{\mathbf{s}}[i] \hat{\mathbf{s}}^H[i] \right. \right. \\ \left. \left. \times \mathbf{T}_s^H[i] \mathbf{A}_s^H[i] \mathbf{H}_{sr_n}^H[i] \right] \right) \quad (33)$$

$$I_d(\mathbf{s}; \mathbf{r}_{rd}) = \log_2 \det \left( \mathbf{I}_{N_a} + E \left[ \mathcal{H}_{rd}[i] \mathcal{A}_r[i] \mathcal{T}_r[i] \hat{\mathbf{s}}[i] \hat{\mathbf{s}}^H[i] \right. \right. \\ \left. \left. \times \mathcal{T}_r^H[i] \mathcal{A}_r^H[i] \mathcal{H}_{rd}^H[i] \right] \right). \quad (34)$$

#### IV. TRANSMIT DIVERSITY OPTIMIZATION

The added spatial diversity and multiplexing that cooperative MIMO achieves compared to single antenna systems make it an attractive transmission methodology. However, undiscerning use of the available channels when a number may have poor transmission characteristics leads to performance degradation, loss of achievable diversity and capacity, and increased interference. These problems can be alleviated by the intelligent selection of transmit antennas of each phase in a process we term TDS. Although this will reduce the total diversity advantage available in the system, it will increase the diversity achieved by the uncoded MMSE-based reception techniques. The requirement to maintain maximum multiplexing gain in the system prohibits selection at the source node, and therefore, we concentrate on selection at the relays, where the matrix  $\mathcal{T}_r[i]$  provides the means to do so in both DF and AF systems. By optimizing the selection of  $\mathcal{T}_r[i]$ , it is possible to optimize the performance of the system as a whole. The limited number of relay antennas and the finite number of possible states of each (on/off) make the selection of  $\mathcal{T}_r[i]$  a discrete and permutation-based task. Therefore, we formulate the selection task for each reception technique as a discrete optimization problem.

##### A. Optimal Linear MMSE Reception

The availability of MSE information from the MMSE reception of second phase makes optimization based on this metric an attractive and low-cost procedure, and therefore, one we will use. We begin by forming a discrete cost function given by

$$\mathcal{T}_r^{\text{opt}} = \arg \min_{\mathcal{T}_r[i] \in \Omega_T} \mathcal{C}[i, \mathcal{T}_r[i]] \\ = \arg \min_{\mathcal{T}_r[i] \in \Omega_T} E \left[ \|\mathbf{s}[i] - \mathbf{W}_d[i, \mathcal{T}_r[i]] \mathbf{r}_d[i, \mathcal{T}_r[i]]\|^2 \right] \quad (35)$$

where the TDS matrix is chosen from a finite set of candidates denoted by  $\Omega_T$ . The solution to (35) can be found by searching the set  $\Omega_T$  that has been generated from the permutations of

active antennas over all the relays. However, the cardinality of such a set is extremely large even at modest numbers of relays and antennas. When all antennas are active and interrelay communication is assumed,  $|\Omega_T| = (N_{ar} \times N_r)!$  and rises further when not all antennas are required to be active. Searching of such a set is clearly impractical, and therefore, methods to reduce  $|\Omega_T|$  are required. We start by transforming the problem from a permutation based to combinatorial based by prohibiting interrelay communications and restricting the allocation of data streams to antennas. The distance between relays and the additional computational expense of interrelay communication lead us to the realistic and common assumption of no interrelay communication that restricts relays to only forward data that have been decoded locally. In addition to this, if  $N_{ar} = N_{as}$  at each relay, then it is possible to preallocate data streams to transmit antennas and therefore remove complexity from the relaying process while reducing  $|\Omega_T|$  without bias toward certain data streams. To do this, we preallocate data streams in such a way to restrict each stream to be transmitted from its correspondingly numbered antennas at each relay. The final condition that we place on the selection of transmit antennas is to specify the size of the subset of active antennas, a value denoted  $N_{asub}$ , where  $1 < N_{asub} < N_r$ . This constraint ensures that a minimum level of achievable diversity is available while ensuring increased robustness by preventing the use of poor quality channels. The combined effect of these conditions and restrictions result in a reduced set  $\Omega_T$ , which has a cardinality of

$$|\Omega_T| = \binom{N_{ar} N_r}{N_{asub}} \quad (36)$$

where  $\text{trace}(\mathcal{T}_r[i]) = N_{asub}$  when TDS is employed. This updated candidate set of TDS matrices can now be inserted into the MSE cost function given by (35), and (13) and (14) are used to provide the necessary MSE information to solve (35).

##### B. Optimal MMSE SIC Reception

The process of TDS can be extended to SIC and offers the prospect of performance advantages over that of standard SIC. As previously set out, the process of TDS is a discrete optimization task whose performance and complexity are heavily dependent on the cardinality of the candidate set of solutions. Consequently, the considered set of solutions will be refined as it has been for in Section IV for optimal linear MMSE reception. This refined set can then be placed in a TDS SIC optimization function, giving

$$\mathcal{T}_r^{\text{opt}} = \arg \min_{\mathcal{T}_r[i] \in \Omega_T} C^{\text{sic}}[i, \mathcal{T}_r[i]] \\ = \arg \min_{\mathcal{T}_r[i] \in \Omega_T} \sum_{l=1}^{N_{as}} E \left[ \left\| \mathbf{s}^l[i] - \mathbf{w}_d^l[i, \mathcal{T}_r[i]] \mathbf{r}_d^l[i, \mathcal{T}_r[i]] \right\|^2 \right]. \quad (37)$$

As before, the task is to then select the optimal TDS matrix from the set  $\Omega_T$  with respect to MSE performance.

### C. MI and Capacity Maximization

TDS can also be applied to MI and capacity maximization. Once again, we will concentrate upon the second phase due to the lack of antenna redundancy at the source node. By transforming the MI framework given in Section III-D into a maximization procedure and inserting (34), we arrive at

$$\begin{aligned} \mathcal{T}_r^{\text{opt}} &= \arg \max_{\mathcal{T}_r[i] \in \Omega_T} I_T(\mathbf{s}; \mathbf{r}_{\text{rd}}, i, \mathcal{T}_r[i]) \\ &= \arg \max_{\mathcal{T}_r[i] \in \Omega_T} \log_2 \det \left( \mathbf{I}_{N_a} + \frac{1}{N_{\text{a\_sub}} \sigma_{\eta_{\text{rd}}}^2} \mathcal{H}_{\text{rd}}[i] \mathcal{T}_r[i] \right. \\ &\quad \left. \times \mathbf{R}_{\hat{\mathbf{s}}} \mathcal{T}_r^H[i] \mathcal{H}_{\text{rd}}^H[i] \right) \end{aligned} \quad (38)$$

where the autocorrelation matrix of the transmitted relay data is given by

$$\mathbf{R}_{\hat{\mathbf{s}}} = E \left[ \hat{\mathbf{s}}[i] \hat{\mathbf{s}}^H[i] \right] = \begin{bmatrix} \mathbf{I}_{N_a} & \cdots & \mathbf{I}_{N_a} \\ \vdots & \ddots & \vdots \\ \mathbf{I}_{N_a} & \ddots & \mathbf{I}_{N_a} \end{bmatrix}. \quad (39)$$

Once again, the optimization problem posed by (39) is a discrete combinatorial problem, where the finite set  $\Omega_T$  contains the potential solutions, and it is required to search a solution.

### D. Iterative Adaptive Linear MMSE Reception

Here, we pose an optimization problem based on low-complexity continuous iterative adaptive linear MMSE reception and the discrete TDS. This is again a joint optimization problem, but the solution to (10) is iteratively found as opposed to that optimally calculated in Section III-A. Placed into a single continuous-discrete hybrid optimization, we arrive at

$$\begin{aligned} &[\mathbf{W}_d^{\text{opt}}[i], \mathcal{T}_r^{\text{opt}}[i]] \\ &= \arg \min_{\mathbf{W}_d[i], \mathcal{T}_r[i] \in \Omega_T} \mathcal{C}^{\text{ad}}[i, \mathcal{T}_r[i], \mathbf{W}_d[i]] \\ &= \arg \min_{\mathbf{W}_d[i], \mathcal{T}_r[i] \in \Omega_T} E \left[ \|\mathbf{s}[i] - \mathbf{W}_d[i, \mathcal{T}_r[i]] \mathbf{r}_d[i, \mathcal{T}_r[i]]\|^2 \right]. \end{aligned} \quad (40)$$

However, due to the use of an LMS algorithm to arrive at  $\mathbf{W}_d[i]$ , ideal MSE information is not available. Consequently, the expectation is required to be replaced with an ensemble average using the destination's squared instantaneous estimation error given by (28). This results in an updated expression for  $\mathcal{C}^{\text{ad}}$  given by

$$\begin{aligned} &\mathcal{C}^{\text{ad}}[i, \mathcal{T}_r[i], \mathbf{W}_d[i]] \\ &= \frac{1}{i} \sum_{k=1}^i \|\mathbf{s}[k] - \mathbf{W}_d[k, \mathcal{T}_r[i]] \mathbf{r}_d[k, \mathcal{T}_r[i]]\|^2. \end{aligned} \quad (41)$$

Additional complexity savings are possible through the use of a recursive averaging procedure instead of the summation

in (41). However, reducing the complexity further by using the unaveraged instantaneous error is not practical due to the AWGN and the unreliable estimates of  $\mathcal{T}_r[i]$ , even at high values of  $i$ .

## V. RELAY SELECTION

In Section IV, optimization of the system is considered through the process of TDS. However, due to the separation between the two phases, the advantages are restricted by the performance of the first phase. The primary problem that exists for MMSE reception with TDS is the possibility of pairing a high-quality second-phase channel with a poor-quality first-phase channel, a problem arising from the lack of consideration of first-phase channel conditions in the TDS process. This can be alleviated through optimization of the pairing of channels. A second aspect of the discrete TDS optimization and methods to solve it is the dependence of their performance and convergence on the cardinality of the set  $\Omega_T$ ; therefore, reducing this further is desirable. However, first-phase performance metrics are not directly available at the destination, interrelay communication is assumed not available, and there is no antenna redundancy at the source. Consequently, direct optimization of the first phase is not possible. To address these issues, we propose to transfer the burden of first-phase optimization onto the destination by performing a joint optimization procedure where the TDS set is optimized based on performance metrics from the relays. This is done by forwarding the available MSE and MI of each relay to the destination and then removing members of the set  $\Omega_T$  based on the first-phase performance of their relays. It is then possible to reduce the probability of a mismatch between the first- and second-phase channels while reducing the size of the TDS set by eliminating the TDS matrices contained within  $\Omega_T$  that transmit from the relay(s) with the highest MSE/lowest MI.

### A. Optimal Linear MMSE Reception

The task of RS is again a discrete combinatorial problem and can be expressed as a cost function. The selection of the poorest performing relay based on its MSE performance under optimal linear reception can be expressed as

$$\begin{aligned} r^{\text{opt}} &= \arg \max_{r[i] \in \Omega_R} \mathcal{F}[i, r[i]] \\ &= \arg \max_{r[i] \in \Omega_R} E \left[ \left\| \mathbf{s}[i] - \mathbf{w}_{\text{sr}[i]}^H[i] \mathbf{r}_{\text{sr}[i]}[i] \right\|^2 \right] \end{aligned} \quad (42)$$

where the set  $\Omega_R$  contains the candidate relays.

For the selection of multiple or  $N_{\text{rem}}$  relays, the MSE of subsets of relays needs to be evaluated. This is done by populating  $\Omega_R$  with vectors of dimensionality  $N_{\text{rem}} \times 1$ , which contain all possible length  $N_{\text{rem}}$  combinations of relay indices such that

$$|\Omega_R| = \binom{N_r}{N_{\text{rem}}} \quad (43)$$

or alternatively, all possible relay subsets of cardinality  $N_{\text{rem}}$ . When placed into an optimization framework, this yields

$$\begin{aligned} \mathbf{r}^{\text{opt}} &= \arg \max_{\mathbf{r}^{[i]} \in \Omega_R} \sum_{j=1}^{N_{\text{rem}}} \mathcal{F} [i, \mathbf{r}_j [i]] \\ &= \arg \max_{\mathbf{r}^{[i]} \in \Omega_R} \sum_{j=1}^{N_{\text{rem}}} E \left[ \left\| \mathbf{s} [i] - \mathbf{w}_{\text{sr}, \mathbf{r}_j [i]}^H [i] \mathbf{r}_{\text{sr}, \mathbf{r}_j [i]} [i] \right\|^2 \right] \end{aligned} \quad (44)$$

where  $\mathbf{r}_j$  represents the  $j$ th element of the vector  $\mathbf{r}$ . Following the solution of (42) or (44), set reduction can commence. This is where the TDS matrices that involve transmission from the relay(s) contained within  $\mathbf{r}^{\text{opt}}$  are removed from  $\Omega_T$ . This reduced TDS set is termed  $\hat{\Omega}_T$ , and its cardinality is given by

$$|\hat{\Omega}_T| = \binom{N_{\text{ar}}(N_r - N_{\text{rem}})}{N_{\text{asub}}}. \quad (45)$$

The TDS optimization given by (35) then operates over this set. As can be seen from (45), increasing  $N_{\text{rem}}$  leads to a decrease in  $|\hat{\Omega}_T|$  and, therefore, the complexity of the optimization process. However, high values of  $N_{\text{rem}}$  greatly restrict the choice of TDS matrices and, therefore, second-phase channels, leading to an increased probability of first- and second-phase channel mismatches. Consequently, there is a balance to be struck between system performance and optimization complexity when choosing  $N_{\text{rem}}$ . In general,  $N_{\text{rem}}$  should remain low in comparison with  $N_r$ ; however, finer adjustment depends on the variance of the qualities of the first- and second-phase channels.

### B. Optimal MMSE SIC Reception

The SIC receiver when implemented in MIMO networks has the ability to offer considerable advantages over linear reception techniques. However, when applied to DF cooperative networks, the separation of the first and second phases can lead to performance degradation and the effective operation of SIC breaking down. In the SIC framework set out in Sections III-B and IV-B, the estimated relay transmit data are formed from a single estimate based on the receive signals from the relayed and direct transmissions. This method operates on the assumption that identical symbol estimates are obtained at each relay for every time instant and that this also occurs at the destination node. However, this assumption is liable to break down. RS can help mitigate this problem by identifying and removing the relay(s) most likely to break the identical relay symbol estimate assumption and then refining the TDS set accordingly.

This is achieved by identifying the relay(s) with the highest MSE as for the optimal linear reception. The discrete MSE cost function to identify the highest MSE relay(s) is given by

$$\begin{aligned} r^{\text{opt}} &= \arg \max_{r^{[i]} \in \Omega_R} \mathcal{F}^{\text{sic}} [i, r^{[i]}] \\ &= \arg \max_{r^{[i]} \in \Omega_R} \sum_{l=1}^{N_{\text{as}}} E \left[ \left\| s^l [i] - \mathbf{w}_{\text{sr}, r^{[i]}}^H [i] \mathbf{r}_{\text{sr}, r^{[i]}}^l [i] \right\|^2 \right] \end{aligned} \quad (46)$$

for the single relay case. Extending RS to multiple relays yields

$$\begin{aligned} \mathbf{r}^{\text{opt}} &= \arg \max_{\mathbf{r}^{[i]} \in \Omega_R} \sum_{j=1}^{N_{\text{rem}}} \mathcal{F}^{\text{sic}} [i, \mathbf{r}_j [i]] \\ &= \arg \max_{\mathbf{r}^{[i]} \in \Omega_R} \sum_{j=1}^{N_{\text{rem}}} \sum_{l=1}^{N_{\text{as}}} E \left[ \left\| s^l [i] - \mathbf{w}_{\text{sr}, \mathbf{r}_j [i]}^H [i] \mathbf{r}_{\text{sr}, \mathbf{r}_j [i]}^l [i] \right\|^2 \right]. \end{aligned} \quad (47)$$

The selected relays are then removed from the candidate TDS set to form  $|\hat{\Omega}_T|$ , which (37) then operates over.

### C. MI and Capacity Maximization

We next address the introduction of RS and its effect on the performance and complexity of the MI TDS process. Equation (39) does not directly take account of the performance of the source-relay transmission, and therefore, there is a likelihood of  $I_{\text{sr}_n} < I_{\text{rn}d}$ . We propose removing from consideration the relays that have the lowest MI between the transmitted data  $\mathbf{s}$  and its received signal  $\mathbf{r}_{\text{sr}_n}$ . This can be achieved by the discrete combinatorial optimization problem given by

$$\begin{aligned} \mathbf{r}^{\text{opt}} &= \arg \min_{\mathbf{r}^{[i]} \in \Omega_R} \sum_{j=1}^{N_{\text{rem}}} I_{\text{R}} \left( \mathbf{s}; \mathbf{r}_{\text{sr}, \mathbf{r}_j [i]}, i, \mathbf{r}_j [i] \right) \\ &= \arg \min_{\mathbf{r}^{[i]} \in \Omega_R} \sum_{j=1}^{N_{\text{rem}}} \log_2 \det \left( \mathbf{I}_{N_a} + \frac{1}{N_a \sigma_{\eta_{\text{sr}}}^2} \mathbf{H}_{\text{sr}, \mathbf{r}_j [i]} [i] \right. \\ &\quad \left. \times \mathbf{R}_{\mathbf{s}} \mathbf{H}_{\text{sr}, \mathbf{r}_j [i]}^H [i] \right) \end{aligned} \quad (48)$$

where the autocorrelation matrix of the transmitted data is given by

$$\mathbf{R}_{\mathbf{s}} = E [\mathbf{s} [i] \mathbf{s}^H [i]] = \mathbf{I}_{N_a}. \quad (49)$$

As before, the removal of a relay reduces the cardinality of the set over which TDS is performed and therefore improves the speed and/or complexity of the corresponding optimization.

### D. Iterative Adaptive Linear MMSE Reception

To further illustrate the use of the discrete approaches proposed, we apply RS to adaptive linear reception. As for optimal linear reception, the optimal relay(s) will be selected in accordance with the optimization problem given by

$$\begin{aligned} \mathbf{r}^{\text{opt}} &= \arg \max_{\mathbf{r}^{[i]} \in \Omega_R} \sum_{j=1}^{N_{\text{rem}}} \mathcal{F}^{\text{ad}} [i, \mathbf{r}_j [i]] \\ &= \arg \max_{\mathbf{r}^{[i]} \in \Omega_R} \sum_{j=1}^{N_{\text{rem}}} E \left[ \left\| \mathbf{s} [i] - \mathbf{w}_{\text{sr}, \mathbf{r}_j [i]}^H [i] \mathbf{r}_{\text{sr}, \mathbf{r}_j [i]} [i] \right\|^2 \right]. \end{aligned} \quad (50)$$

However, as before, in the LMS adaptation, the expectation is not performed, and the MSE is replaced with an ensemble average based on the instantaneous squared relay

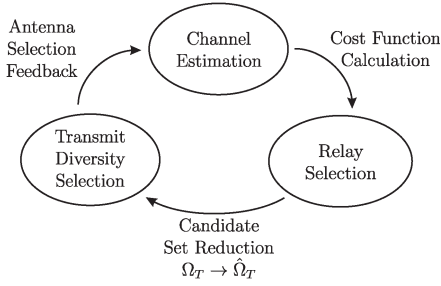

Fig. 2. Algorithm flow diagram.

estimation error given by (30). Reformulating  $\mathcal{F}^{\text{ad}}$  accordingly, we arrive at

$$\mathcal{F}^{\text{ad}}[i, \mathbf{r}_j[i]] = \frac{1}{i} \sum_{k=1}^i \left[ \left\| \mathbf{s}[k] - \mathbf{w}_{\text{sr}_{r_j[k]}}^H [i] \mathbf{r}_{\text{sr}_{r_j[i]}} [k] \right\|^2 \right]. \quad (51)$$

### E. Amplify-and-Forward

Due to the lack of decoding at each relay in an AF system, MSE information is not available, and therefore, a secondary optimization criteria is required. In this paper, we choose the end-to-end SNR of each relay branch and perform RS based on the branch(es) with the lowest SNR. Interpreting this in the multiple RS framework yields

$$\mathbf{r}^{\text{opt}} = \arg \min_{\mathbf{r}^{[i]} \in \Omega_R} \sum_{j=1}^{N_{\text{rem}}} \mathcal{K}[i, \mathbf{r}_j[i]] \quad (52)$$

where  $\mathcal{K}[i, \mathbf{r}_j[i]]$  is defined in (53), shown at the bottom of the page. The end-to-end SNR given by (53) is constructed from the compounded channels of the AF system. The numerator is formed from the signal power transmitted through each relay in the system, and the noise in the denominator is formed from the second-phase noise ( $\sigma_{\text{sr}}^2 \mathbf{I}_{N_a}$ ) and the amplified first-phase noise ( $\mathbf{A}_{\text{r}_{r_j[i]}\text{d}[i]} \sigma_{\text{sr}}^2 \mathbf{I}_{N_a} \mathbf{A}_{\text{r}_{r_j[i]}\text{d}[i]}^H$ ).

## VI. PROPOSED ALGORITHMS

In this section, we present algorithms to solve the optimization problems of Sections IV and V. We propose that the TDS and RS schemes operate in a joint and cyclic fashion, where RS constantly refines the set that TDS operates over. However, to obtain solutions to the optimization problems, backward CSI is required at the relays and destination. Due to the cyclic nature of the proposed optimization framework, it is possible to insert channel estimation without interrupting the process, and a flow diagram given in Fig. 2 shows this.

The optimal but most complex method to obtain solutions to the range of TDS and RS optimization problems is to perform

TABLE I  
PROPOSED DISCRETE STOCHASTIC TDS ALGORITHM  
FOR LINEAR MMSE RECEPTION

Step
<b>1. Initialization</b> choose $\mathcal{T}[1] \in \Omega_T, \mathcal{T}^W[1] \in \Omega_T, \pi_T[1, \mathcal{T}[1]] = 1,$ $\pi_T[1, \tilde{\mathcal{T}}] = 0$ for $\tilde{\mathcal{T}} \neq \mathcal{T}[1]$
<b>2. For the time index <math>i = 1, 2, \dots, N</math></b> choose $\mathcal{T}^C[i] \in \Omega_T$
<b>3. Comparison and update of the worst performing relay</b> if $C[i, \mathcal{T}^C[i]] < C[i, \mathcal{T}^W[i]]$ then $\mathcal{T}^W[i+1] = \mathcal{T}^C[i]$ otherwise $\mathcal{T}^W[i+1] = \mathcal{T}^W[i]$
<b>4. State occupation probability (SOP) vector update</b> $\pi_T[i+1] = \pi_T[i] + \mu[i+1](\mathbf{v}_{\mathcal{T}^W[i+1]} - \pi_T[i])$ where $\mu[i] = 1/i$
<b>5. Determine the largest SOP vector element and select the optimum TDS matrix</b> if $\pi_T[i+1, \mathcal{T}^W[i+1]] > \pi_T[i+1, \mathcal{T}[i]]$ then $\mathcal{T}[i+1] = \mathcal{T}^W[i+1]$ otherwise $\mathcal{T}[i+1] = \mathcal{T}[i]$

an exhaustive search of the respective sets at each time instant. However, due to the power consumption and complexity constraints on nodes within the system, such an approach is not possible; however, it can act as a lower bound on performance. Iterative methods that converge to the optimal solution present an alternative low-complexity approach, and therefore, this family of methods will be used in this paper. Conventional iterative algorithms, including LMS and RLS, are unsuitable for discrete problems, and therefore, discrete stochastic algorithms (DSAs) are chosen. In this paper, a low-complexity DSA first presented in [30] and later used [5] is selected. Each set of optimization problems can then be jointly and iteratively solved at little additional computational cost above that of the reception and decoding processes at each time instant.

For the optimization problems of Sections IV and V, we propose a low-complexity DSA that jointly optimizes RS and TDS in accordance with (35) and (42), (37) and (46), (48) and (39), and (40) and (50), and converges to the optimal exhaustive solution. First, in Table I, we present the TDS segment of the algorithm that optimizes the selection of the TDS matrix  $\mathcal{T}_r$  with regard to optimal linear MMSE reception. At each iteration, the MSE of a randomly chosen candidate TDS matrix ( $\mathcal{T}_r^C$ ) (step 2) and that of the best performing TDS matrix currently known ( $\mathcal{T}_r^B$ ) are calculated (step 3). Via a comparison, the lower MSE TDS matrix is designated  $\mathcal{T}_r^B$  for the next iteration (step 3). The current solution and TDS matrix chosen for transmission ( $\mathcal{T}_r$ ) is denoted as the current optimum and is the TDS matrix that has occupied  $\mathcal{T}_r^B$  most frequently over the course of the packet up to the  $i$ th time instant. This averaging/selection process is performed by allocating each member of  $\Omega_T$  a  $|\Omega_T| \times 1$  unit vector,  $\mathbf{v}_l$ , which has a 1 in its corresponding position in  $\Omega_T$ , i.e.,  $\mathbf{v}_{\mathcal{T}_r^B[i]}$  is the label of the best performing TDS matrix at the  $i$ th iteration. The current optimum is then chosen and tracked by means of a  $|\Omega_T| \times 1$  state occupation probability vector  $\pi_T$ . This vector is updated at each iteration by adding  $\mathbf{v}_{\mathcal{T}_r^B[i+i]}$

$$\mathcal{K}[i, \mathbf{r}_j[i]] = \frac{\text{trace} \left( \mathbf{H}_{\text{r}_{r_j[i]}\text{d}[i]} \mathbf{A}_{\text{r}_{r_j[i]}\text{d}[i]} \mathbf{H}_{\text{sr}_{r_j[i]}} [i] \mathbf{A}_s [i] \mathbf{A}_s^H [i] \mathbf{H}_{\text{sr}_{r_j[i]}}^H [i] \mathbf{A}_{\text{r}_{r_j[i]}\text{d}[i]}^H [i] \mathbf{H}_{\text{r}_{r_j[i]}\text{d}[i]}^H [i] \right)}{\text{trace} \left( \mathbf{H}_{\text{r}_{r_j[i]}\text{d}[i]} \mathbf{A}_{\text{r}_{r_j[i]}\text{d}[i]} \sigma_{\text{sr}}^2 \mathbf{I}_{N_a} \mathbf{A}_{\text{r}_{r_j[i]}\text{d}[i]}^H [i] \mathbf{H}_{\text{r}_{r_j[i]}\text{d}[i]}^H [i] + \sigma_{\text{rd}}^2 \mathbf{I}_{N_a} \right)} \quad (53)$$

TABLE II  
PROPOSED DISCRETE STOCHASTIC RS ALGORITHM  
FOR LINEAR MMSE RECEPTION

Step
<b>1. Initialization</b>
choose $r[1] \in \Omega_R$ , $r^W[1] \in \Omega_R$ , $\pi_R[1, r[1]] = 1$ , $\pi_R[1, \tilde{r}] = 0$ for $\tilde{r} \neq r[1]$
<b>2. For the time index <math>i = 1, 2, \dots, N</math></b>
choose $r^C[i] \in \Omega_R$
<b>3. Comparison and update of the worst performing relay</b>
if $\mathcal{F}[i, r^C[i]] > \mathcal{F}[i, r^W[i]]$ then $r^W[i+1] = r^C[i]$ otherwise $r^W[i+1] = r^W[i]$
<b>4. State occupation probability (SOP) vector update</b>
$\pi_R[i+1] = \pi_R[i] + \mu[i+1](\mathbf{v}_{r^W[i+1]} - \pi_R[i])$ where $\mu[i] = 1/i$
<b>5. Determine the largest SOP vector element and select the optimum relay</b>
if $\pi_R[i+1, r^W[i+1]] > \pi_R[i+1, r[i]]$ then $r[i+1] = r^W[i+1]$ otherwise $r[i+1] = r[i]$
<b>6. TDS Set Reduction</b>
remove members of $\Omega_T$ which utilize $r[i+1]$ ( $\Omega_T \rightarrow \hat{\Omega}_T$ )

and subtracting the previous value of  $\pi_T$  (step 4). The current optimum is then determined by selecting the largest element in  $\pi_T$  and its corresponding entry in  $\Omega_T$  (step 5). Through this process, the current optimum converges toward and tracks the exhaustive solution [30]. An alternative interpretation of the proposed algorithm is to view the transitions  $\mathcal{T}_r^B[i] \rightarrow \mathcal{T}_r^B[i+1]$  as a Markov chain and the members of  $\Omega_T$  as the possible transition states. The current optimum can then be defined as the most visited state.

Table II presents the discrete stochastic RS algorithm that provides the algorithm in Table I with a refined TDS set ( $\Omega_T \rightarrow \hat{\Omega}_T$ ) in accordance with (42). The operation of the RS algorithm in Table II is similar to that of the TDS algorithm but with a reversed inequality of step 3, enabling convergence to the highest MSE relay(s), and the addition of step 6 that performs set reduction, as described in Section V. In Table II, a single relay is selected, but extension to the selection of multiple relays is straightforward and involves replacing  $R$  with the vector form  $\mathbf{r}$  and using the MSE calculation of (44).

To adapt the algorithms in Tables I and II for use with SIC reception, MI optimization, and adaptive reception, a number of alterations are required. These include reversing the inequality of step 3 for MI optimization and replacing the metric calculation functions, also of step 3, for all schemes. Details of the required changes are given in Table III, where alterations with respect to RS are for the selection of multiple relays.

Due to the purely adaptive nature of the schemes when iterative adaptive reception is used, a number of further alterations and clarifications are required for correct operation. First, the updating of the receive filter at the destination for each TDS matrix and the accompanying error calculation occur only when its corresponding TDS matrix is selected as either  $\mathcal{T}$ ,  $\mathcal{T}^C$  or  $\mathcal{T}^W$  during the operation of the algorithm given in Table I. Second, due to the parallel convergence of the relay filters, destination filters, TDS, and RS, an extended convergence period is expected. Consequently, the step size of step 4 ( $\mu[i]$ ) is not suitable since it more heavily weights early samples. To avoid this, a fixed step size is implemented that equally weights all samples and assists convergence at large values of  $i$ .

## VII. ANALYSIS

In this section, we analyze and discuss four major aspects of the proposed algorithms that encompass their advantages over existing methods. The four areas covered are computational complexity, convergence, diversity gain, and feedback requirements.

### A. Complexity

The iterative operation of the TDS algorithms offers a clear complexity advantage over an exhaustive search of the entire set of solutions. These savings result from a significant reduction in the number of calculations at each time instant for each set considered compared to the exhaustive search. However, the complexity benefits are a tradeoff against convergence as is often found in mobile systems. In contrast to this, performing RS in combination with the TDS algorithm improves both convergence and complexity. This results from the low complexity of the RS procedure being outweighed by the saving made from the TDS process operating over the reduced cardinality set  $\hat{\Omega}$ . In Fig. 3, the computational complexity in terms of the (average) total number of complex multiplications and additions is given for the optimal exhaustive methods and the proposed DSA when optimal linear MMSE reception is used. For simplicity and conciseness, in this figure and throughout the remainder of this paper,  $N_a$  is used to refer to the number of antennas at all nodes, where  $N_a = N_{as} = N_{ar} = N_{ad}$ . As one can see, there are substantial complexity savings from the use of the proposed algorithms over the exhaustive solutions; these are savings that increase with the number of relays and total antenna elements in the system. A second feature to highlight are the savings made from introducing RS into the optimal exhaustive and proposed methods. These savings also increase with system size and confirm that those made by RS exceed the cost of its implementation. As one can see from Fig. 3, the savings also increase with  $N_{rem}$ , which is a feature explained by the following relationship:

$$(|\Omega_{R, N_{rem}=2}| - |\Omega_{R, N_{rem}=1}|) \leq \left( \left| \hat{\Omega}_{T, N_{rem}=1} \right| - \left| \hat{\Omega}_{T, N_{rem}=2} \right| \right). \quad (54)$$

Table IV presents the analytical expressions for the complexity of the linear MMSE-based TDS and RS algorithms along with their corresponding exhaustive implementations. The presence of the set cardinality in all expressions accounts for each scheme's complexity dependence on the set over which it operates. Central to the cardinality of  $\Omega_T$  and  $\hat{\Omega}_T$  is the choice of  $N_{asub}$ , as shown by (36) and (45). Consequently, the complexities of the schemes are heavily dependent of the binomial relationship between the number of considered antennas and  $N_{asub}$ . The reasons behind the complexity reduction achieved by the iterative RS algorithm are evident from the expressions for the iterative TDS and iterative TDS with RS. The majority of the savings arise from the difference between  $2|\Omega_T|$  and  $2|\hat{\Omega}_T| + 2|\Omega_R|$ , and by referring back to the set cardinality expressions given by (36), (45), and (43), the characteristics of the lines in Fig. 3 can be accounted for.



TABLE III  
TDS AND RS ALGORITHM ALTERATIONS

	TDS Step 3	RS Step 3
Linear MMSE	if $C[i, \mathcal{T}^C[l]] < C[i, \mathcal{T}^W[l]]$	if $\sum_{j=1}^{N_{\text{rem}}} \mathcal{F}[i, r_j^C[l]] > \sum_{j=1}^{N_{\text{rem}}} \mathcal{F}[i, r_j^W[l]]$
SIC MMSE	if $C^{\text{sic}}[i, \mathcal{T}^C[l]] < C^{\text{sic}}[i, \mathcal{T}^W[l]]$	if $\sum_{j=1}^{N_{\text{rem}}} \mathcal{F}^{\text{sic}}[i, r_j^C[l]] > \sum_{j=1}^{N_{\text{rem}}} \mathcal{F}^{\text{sic}}[i, r_j^W[l]]$
MI	if $I_T(\mathbf{s}; \mathbf{r}_{\text{rd}}, i, \mathcal{T}^C[l]) > I_T(\mathbf{s}; \mathbf{r}_{\text{rd}}, i, \mathcal{T}^W[l])$	if $\sum_{j=1}^{N_{\text{rem}}} I_R(\mathbf{s}; \mathbf{r}_{\text{rd}}, i, r_j^C[l]) < \sum_{j=1}^{N_{\text{rem}}} I_R(\mathbf{s}; \mathbf{r}_{\text{rd}}, i, r_j^W[l])$
Linear Adaptive	if $C^{\text{ad}}[i, \mathcal{T}^C[l], \mathbf{W}_d[l]] < C^{\text{ad}}[i, \mathcal{T}^W[l], \mathbf{W}_d[l]]$	if $\sum_{j=1}^{N_{\text{rem}}} \mathcal{F}^{\text{ad}}[i, r_j^C[l]] > \sum_{j=1}^{N_{\text{rem}}} \mathcal{F}^{\text{ad}}[i, r_j^W[l]]$
AF - Linear MMSE and SNR	if $C[i, \mathcal{T}^C[l]] < C[i, \mathcal{T}^W[l]]$	if $\sum_{j=1}^{N_{\text{rem}}} \mathcal{K}[i, r_j^C[l]] < \sum_{j=1}^{N_{\text{rem}}} \mathcal{K}[i, r_j^W[l]]$

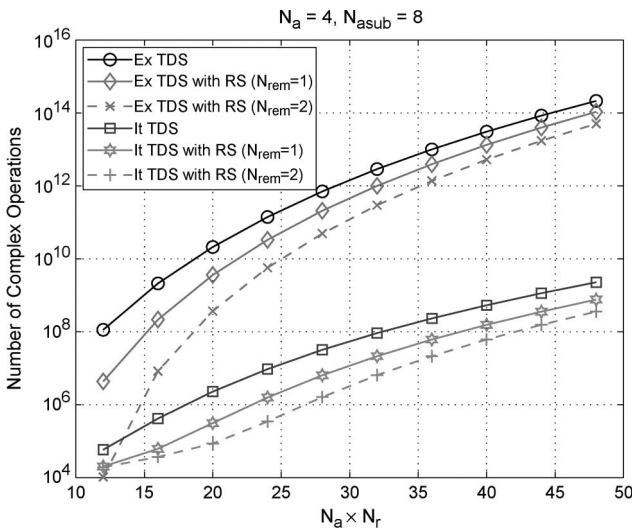

Fig. 3. Computational complexity of optimal exhaustive (Ex) and proposed iterative (It) MMSE schemes.

### B. Feedback Requirements

A significant advantage of the schemes proposed in this paper are their low feedback requirements. No precoding is required at the transmitting nodes, TDS solely operates in the second phase, and all receptions at the receiving nodes only require locally available CSI. Consequently, only the feedback of the TD selections to the relays is required. For RS, relay MSE information is required to be forwarded, which is a process that occurs during the training period. As covered earlier in this paper, TDS can be interpreted as discrete power control with one bit quantization, where the relative transmit power from each antenna is constrained to either 1 or 0. As a result,  $N_{\text{ar}}$  feedback bits are required for TDS at each relay node and a total of  $N_r \times N_{\text{ar}}$  bits for the overall system, a figure that grows linearly with the size of the system. This low feedback rate increases the robustness of the TDS and RS optimization processes and assists in maintaining performance up to significant levels of feedback errors. Additionally, the impact on the capacity of the system is small as only a brief time slot is required for transmission of the feedback information. However, the forwarding of the relay MSE information is subject to quantization, and it is, therefore, the number of quantization levels that determines the rate of the forwarded

data. In this paper, a binary symmetric channel is used to model the feedback and feedforward channels, the quality of which is controlled by the probability of the error term, where  $0 \leq p_e \leq 1$ . Fig. 4 gives the system model when the feedback channel is implemented.

### C. Diversity

A significant benefit of multirelay MIMO systems is the diversity advantage and spatial multiplexing gains they offer. However, obtaining full receive diversity requires complex optimum nonlinear methods such as sphere and maximum likelihood decoding. In this paper, receivers based on linear MMSE filtering have been used, and therefore, it is not possible to obtain the full diversity on offer unless so form of coding is implemented. Nevertheless, the diversity advantage available to uncoded MMSE receivers can be maximized and the accompanying interference suppression improved. The method of TDS and RS restricts the number transmit paths used and therefore lowers the maximum diversity advantage available to the optimum nonlinear receivers from  $d^* = N_{\text{ad}}(1 + (N_r N_{\text{ar}}/N_{\text{as}}))$  to  $d^* = N_{\text{ad}}(N_{\text{asub}}/N_{\text{ar}} + 1)$  when full spatial multiplexing gain is maintained. However, it enables the lower complexity MMSE-based techniques to increase their exploitation of the diversity at an SNR of interest by removing paths that bring little or no advantage to the cooperative transmissions of the first and second phase and dedicating increased transmit power over the remaining transmission routes.

### D. Convergence

Here, we specify the condition under which convergence of the proposed discrete algorithms is guaranteed and discuss the behavior of the proposed algorithms under nonideal conditions. Considering the combinatorial nature of the problems and algorithms presented in this paper, convergence is judged against the optimal exhaustive solution at each time instant. Due to the application of the proposed schemes in practical communications systems, we predominantly concentrate upon BER and squared estimation error as a measure of performance and convergence.

Global convergence of the proposed algorithms is dependent on two assumptions: 1) the independence between the

TABLE IV  
 PROPOSED ALGORITHM COMPLEXITY

Algorithm	No. of Complex Additions and Multiplications
Iterative TDS	$3 \left( 3(N_a N_r)^3 + 2N_a(N_a N_r)^2 + N_a N_r(6N_a^2 + 4N_a + 5) + 8N_a^3 - N_a^2 + N_a + 1 \right) + 5N_r N_a^3 + N_r N_a + N_r + 2 \Omega_T $
Iterative TDS with RS	$3 \left( 3(N_a N_r)^3 + 2N_a(N_a N_r)^2 + N_a N_r(6N_a^2 + 4N_a + 5) + 8N_a^3 - N_a^2 + N_a + 1 \right) + 5N_r N_a^3 + N_r N_a + N_r + 6N_a^3 - 3N_a^2 + 2 \hat{\Omega}_T  + 2 \Omega_R $
Exhaustive TDS	$ \Omega_T  \left( 3(N_a N_r)^3 + 2N_a(N_a N_r)^2 + N_a N_r(6N_a^2 + 4N_a + 5) + 8N_a^3 - N_a^2 + N_a + 1 \right) + 5N_r N_a^3 + N_r N_a + N_r$
Exhaustive TDS with RS	$ \hat{\Omega}_T  \left( 3(N_a N_r)^3 + 2N_a(N_a N_r)^2 + N_a N_r(6N_a^2 + 4N_a + 5) + 8N_a^3 - N_a^2 + N_a + 2 \right) + 7N_r N_a^3 - N_r N_a^2 + N_r N_a + N_r + 2 \Omega_R $

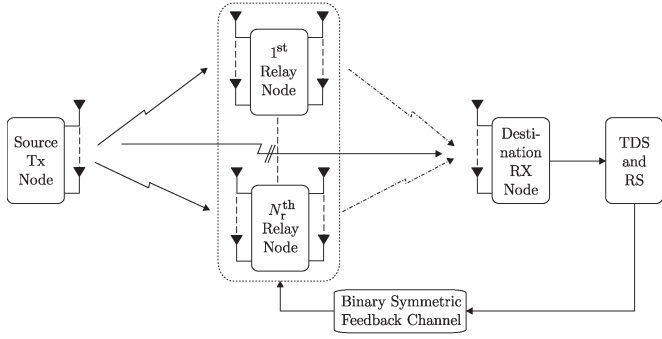

Fig. 4. Cooperative MIMO system model with feedback model.

observations used for the objective function calculations and 2) the satisfaction of

$$\Pr \{ \mathcal{C}_T [i, t^{\text{opt}}] > \mathcal{C}_T [i, t[i]] \} > \Pr \{ \mathcal{C}_T [i, t[i]] > \mathcal{C}_T [i, t^{\text{opt}}] \} \quad (55)$$

$$\Pr \{ \mathcal{C}_T [i, t^{\text{opt}}] > \mathcal{C}_T [i, t^C [i]] \} > \Pr \{ \mathcal{C}_T [i, t[i]] > \mathcal{C}_T [i, t^C [i]] \} \quad (56)$$

for the MMSE TDS and

$$\Pr \{ \mathcal{F}_R [i, r^{\text{opt}}] > \mathcal{F}_R [i, r[i]] \} > \Pr \{ \mathcal{F}_R [i, r[i]] > \mathcal{F}_R [i, r^{\text{opt}}] \} \quad (57)$$

$$\Pr \{ \mathcal{F}_R [i, r^{\text{opt}}] > \mathcal{C}_R [i, r^C [i]] \} > \Pr \{ \mathcal{F}_R [i, r[i]] > \mathcal{C}_R [i, r^C [i]] \} \quad (58)$$

for the MMSE RS. When these conditions are met and independent observations utilized,  $t[i] \rightarrow t^{\text{opt}}$  and  $r[i] \rightarrow r^{\text{opt}}$  are guaranteed of operating independently [5], [30]. However, due to the joint of operation of TDS and RS and the practical difficulties of obtaining numerous independent observations under the system model presented in this paper, the proof of convergence is intractable and, therefore, not guaranteed. Nevertheless, throughout the simulations presented in this paper and extensive experimentation, excellent steady-state convergence performance has been observed. Further support for this conclusion is presented in [5], where no convergence issues were encountered as a result of the lack of independent observations. This, therefore, indicates that the lack of independent observations is not a problem for the proposed schemes; however, the choice of  $\mu$  does need to be taken into consideration. For

example, if a large initial step size is chosen for the TDS process and a small step size for the RS process, it is possible that the TDS process will become trapped in a state associated with a local minimum and therefore fail to converge to the exhaustive TDS with RS solution. Additional care has to be taken when studying the convergence of the schemes that feature adaptive reception. As previously specified, the step size of TDS and RS algorithms is fixed for the adaptive MMSE implementation to aid convergence of TDS and RS at large  $i$  and avoid becoming trapped in a nonoptimal state. Although effective, the rate of convergence will still lag behind the optimal scheme due to not only the convergence of the LMS adaptive filter algorithms and the ensemble error but also the convergence of a total of four algorithms in parallel for TDS with RS. To aid the convergence of all schemes,  $|\Omega_R| \ll |\hat{\Omega}_T|$  to ensure RS converges significantly before TDS ( $|\Omega_R| < |\hat{\Omega}_T|$ ). This, therefore, minimizes the number of TDS iterations performed on the nonoptimal  $\hat{\Omega}_T$  set and assists in ensuring that the detrimental convergence effects of a changing  $\hat{\Omega}_T$  in the initial transient are outweighed by the benefits of TDS operating over a significantly reduced cardinality set.

## VIII. SIMULATIONS

In this section, simulations of the proposed algorithms and existing techniques are presented. For all schemes, comparisons will be given between the optimal exhaustive (exhaustive TDS and exhaustive TDS and RS), the standard cooperative system (no TDS), noncooperative transmission (noncooperative), and iterative (iterative TDS and iterative TDS and RS) implementations. QPSK modulation is used, and equal power allocation will be maintained in all phases for DF schemes, where  $\mathcal{A}_r [i] = 1/\sqrt{N_{\text{asub}}}\mathbf{I}_{N_{\text{ar}}N_r}$  when TDS is employed, and  $\mathcal{A}_r [i] = 1/\sqrt{N_{\text{ar}}N_r}\mathbf{I}_{N_{\text{ar}}N_r}$  for standard cooperative transmission. For AF, the transmit power of the  $m$ th antenna at the  $n$ th relay when TDS is employed is given by

$$\mathbf{A}_{r_n, m} [i] \frac{1}{\sqrt{N_{\text{asub}}\mathbf{H}_{\text{sr}_n, m} [i]\mathbf{H}_{\text{sr}_n, m}^H [i] + \sigma_{\text{sr}}^2}} \quad (59)$$

where  $\mathbf{H}_{\text{sr}_n, m}$  denotes the  $m$ th row of the matrix  $\mathbf{H}_{\text{sr}_n}$ . Equation (59) therefore ensures  $E[\mathcal{A}_r^H [i]\mathcal{A}_r [i]] = 1$ . For standard cooperative transmission,  $N_{\text{asub}}$  is replaced with  $N_{\text{ar}}$ , and to provide CSI, RLS channel estimation will be used [33], [36], [37]. The RLS variables  $\mathbf{P}_{\hat{\mathcal{H}}_{\text{rd}}}$ ,  $\mathbf{P}_{\hat{\mathbf{H}}_{\text{sr}_n}}$ , and  $\mathbf{P}_{\hat{\mathbf{H}}_{\text{sd}}}$  are initialized as identity matrices and  $\lambda$ , and the exponential forgetting factor

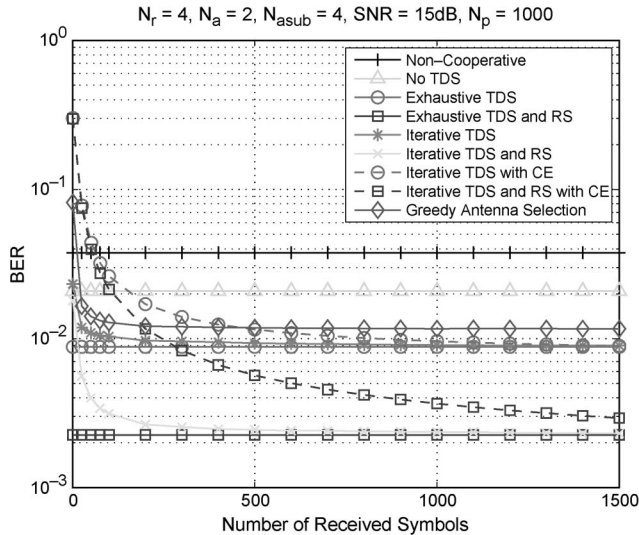

Fig. 5. BER performance versus the number of received symbols for the proposed schemes with full and estimated CSI and optimal linear receivers.

is 0.9. The initial values of  $\hat{\mathcal{H}}_{rd}$ ,  $\hat{\mathbf{H}}_{sr,n}$ , and  $\hat{\mathbf{H}}_{sd}$  are zero matrices. Throughout all simulations,  $N_{as} = N_{ar} = N_{ad} = N_a$ , where  $N_a$  is specified in each plot. Each simulation is averaged over  $N_p$  packets, where  $N_p$  is specified in each plot, and the coherence time is equal to or greater than the period of the packets.

Fig. 5 shows the BER performance versus the number of received symbols for the proposed schemes and the existing GAS method. For the RS schemes, a single relay is removed, and the estimated CSI is used for optimal linear MMSE reception at all nodes. The performance of the TDS schemes exceeds that of the standard cooperative system, and GAS and RS further improve the performance in terms of convergence and steady state. The performance improvement over GAS highlights the drawback of its restricted antenna selection procedure and the resulting low probability that it will converge to the exhaustive solution. The proposed schemes do not suffer from such a restrictive antenna selection procedure and therefore possess a clear advantage of GAS. The improvement brought about by RS indicates a decrease in the likelihood of channel mismatch between the first and second phases and confirms the improvement in convergence performance obtained by refining and reducing the cardinality of the set over which the TDS operates. Finally, the behavior of the CE schemes indicates that TDS, RS, and CE jointly operate correctly and allow the convergence to the exhaustive solution if an appropriate value of  $\lambda$  is chosen.

The BER performance versus SNR of the proposed optimal linear MMSE-based algorithms is shown in Fig. 6. The steeper gradient of the proposed schemes indicates that increased diversity has been achieved by the RS schemes at the SNR of interest, which are gains that increase when  $N_{rem} = 2$ . Improved interference mitigation is also obtained as evidenced by the shifting of the TDS plot compared with the standard system. In general, the BER performance of the iterative scheme closely matches the exhaustive performance after 500 iterations; however, there is an increasing discrepancy for the schemes with  $N_{rem} = 2$  as the SNR increases. This is partially accounted for by the lower BER but is also explained by the increased

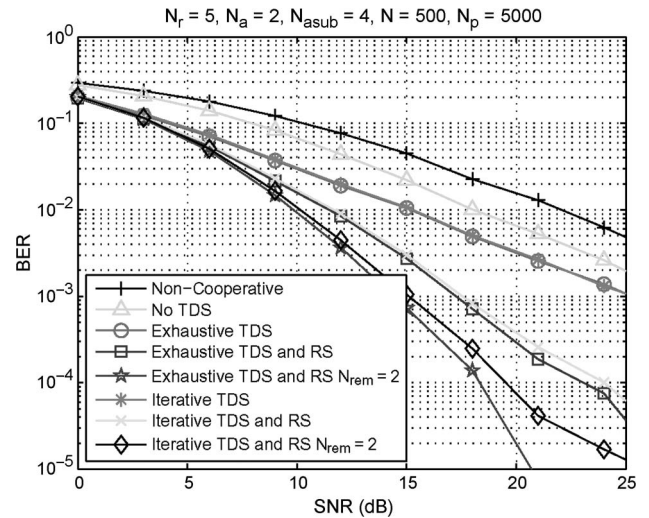

Fig. 6. BER performance versus SNR for the proposed schemes with optimal linear receivers and  $N_{rem} = 1, 2$ .

size of  $\Omega_R$  and the increased time the DSA takes to converge to the optimal  $\Omega_R$ . This results in the TDS portion of the algorithm not operating on the optimal  $\hat{\Omega}_T$  for a significant number of initial iterations and therefore increasing the BER convergence time. The diminishing returns associated with increasing  $N_{rem}$  are also evident from Fig. 6. This is due to the worst performing relaying introducing the highest number of errors, and therefore, the removal of this relay will result in the most significant increase in performance. The aforementioned factors highlight the importance of the choice of  $N_{rem}$  relative to  $N_R$ . Too small a value and a near-optimal BER value will not be achieved because poorly performing relays are not removed from consideration by TDS, but too large a value will result in slow convergence of the RS algorithm and overly restrict the pairing of first- and second-phase channels that TDS with RS achieves. Consequently, the choice of  $N_{rem}$  is similar to the choice of a step size in a stochastic gradient algorithm in as much that it is a tradeoff between convergence and steady-state performance. The choice of  $N_{asub}$  also requires careful consideration. Primarily,  $N_{asub}$  must be chosen so that sufficient diversity is available in the system; however, the effect of  $N_{asub}$  on the cardinality of  $\hat{\Omega}_T$  must also be taken into consideration if an extended convergence period is to be avoided.

An important aspect of cooperative MIMO systems and transmission strategies is their performance in the presence of correlated channels. Fig. 7 shows the performance of the optimal linear MMSE-based schemes over the correlated channels specified in Section VIII-A. Improved interference mitigation and diversity have been achieved by the proposed TDS with RS scheme, and no significant convergence problems are evident. However, as expected, the performance has been degraded by correlated channels compared to the results in Fig. 6, which are based on uncorrelated channels.

The effect of introducing SIC based on optimal linear MMSE reception is illustrated in Fig. 8. The advantage in interference suppression is evident from the shifted plots, but there are also diversity gains when RS is considered. The gains of introducing RS when SIC is utilized are substantial and exceed that of

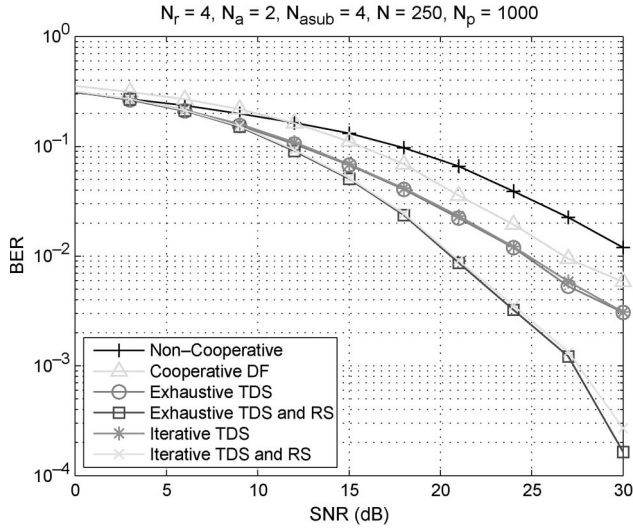

Fig. 7. BER performance versus SNR for the proposed schemes with optimal linear receivers when operating over correlated channels.

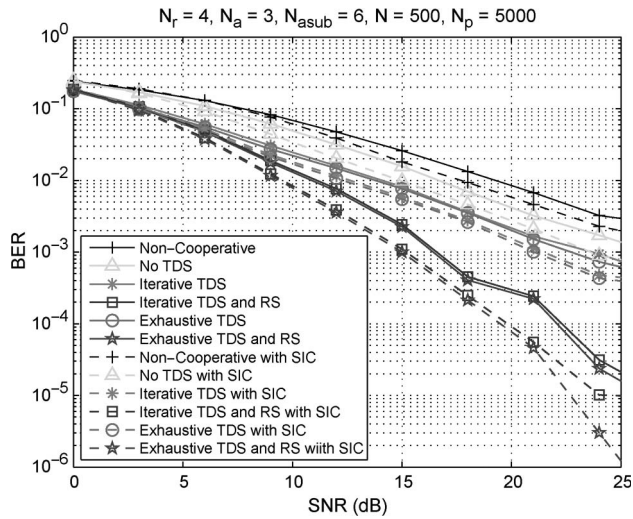

Fig. 8. BER performance versus SNR for the proposed schemes with SIC.

introducing RS when SIC is not used. This can be attributed to the decrease in probability that different symbols have been transmitted from the active relays that RS brings about, thus reducing the likelihood that the identical transmit symbol assumption in Section V-B is violated.

Fig. 9 presents the BER performance versus the number of received symbols for TDS and TDS with RS when joint adaptive linear MMSE reception is used at all nodes. The rate of convergence of both iterative algorithms has been slowed considerably due to the convergence of the receive filters and their ensemble error, as well as because of the challenges of several adaptive schemes operating in parallel. The TDS algorithm converges to its optimal value, but when RS is introduced, convergence issues arise. This is due to the convergence of the receivers at the relay nodes and the resulting initial iterations of the RS algorithm that operate on nonoptimal decoding error information.

Fig. 10 illustrates the performance of the proposed iterative schemes when implemented in an AF system. Both of the

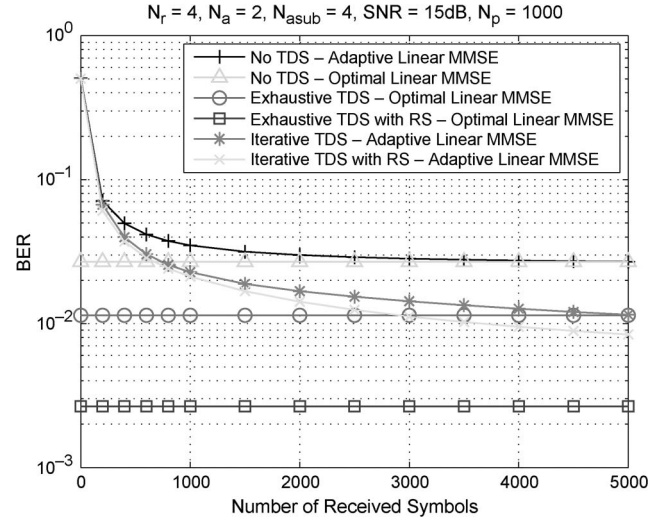

Fig. 9. BER performance versus the number of received symbols for proposed schemes with joint adaptive linear MMSE receive filters.

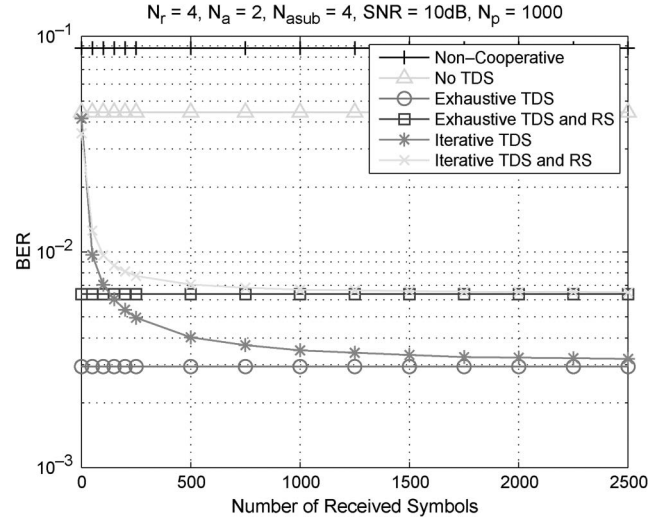

Fig. 10. BER performance versus the number of received symbols for the proposed schemes in an AF system with optimum linear receivers.

iterative schemes converge to their optimal exhaustive counterparts, and as expected, the TDS and RS schemes display increased rates of convergence compared with TDS alone. However, RS does not bring about an improvement in steady state performance as in DF systems. This results from the use of branch SNR as secondary RS criteria because MSE data are not available from the relays. Therefore, integration with the MSE-based TDS at the destination is not as complete.

In previous simulations, the feedback and feedforward channels are assumed error free, but in reality, this assumption is likely to breakdown. Fig. 11 gives the BER performance versus the probability of error in each individual feedback and feedforward bit when no error coding and correction are employed and a 2-bit quantization is used for the MSE forwarding. The TDS and the TDS with RS schemes are compared when optimal linear receivers with full backward CSI are used at all nodes. Both schemes provide improved performance over the noncooperative system up until the probability of error reaches  $\approx 0.1$ , and their performance converges. At this point, 57% of

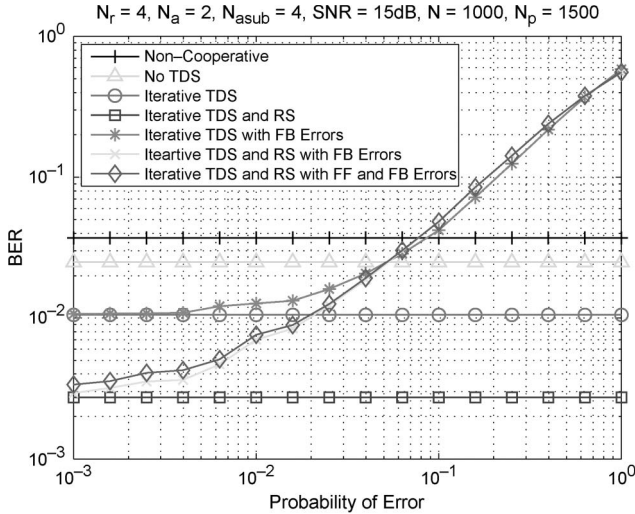

Fig. 11. BER performance versus the probability of feedback errors for the proposed schemes with optimal linear receivers.

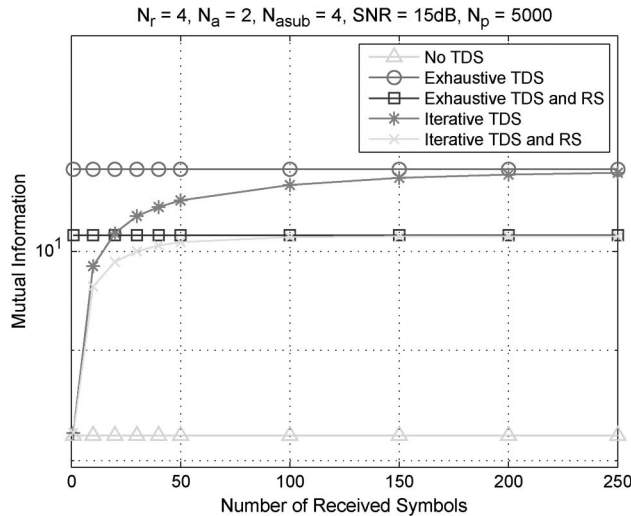

Fig. 12. MI performance versus the number of received symbols for the proposed schemes.

the  $N_a N_r$  feedback bit packets have at least one error. The performance degradation is due to the nonoptimal second-phase channels being utilized, incorrect total transmit power, and incorrect values used in the calculation of the MMSE receiver at the destination node. The effect on system performance of errors and quantization in the forwarded MSE is extremely small and indicates that the RS process is highly robust and requires only very coarse quantization.

Fig. 12 gives the MI of the proposed schemes versus the number of iterations of the DSA. Both schemes achieve gains over the standard system, but RS results in a small performance loss compared with the TDS scheme. This is due to the MI optimization given by (39) not taking into account the MI of the first phase because of the inherent separation between phases in DF systems. However, the TDS with RS scheme has lower complexity and increased speed of convergence compared to TDS alone due to the refined set  $\hat{\Omega}_T$  and its lower cardinality. Additionally, when utilizing RS, the probability of

the MI/capacity of the first phase being unable to satisfy that of the second phase is reduced.

### A. Correlated Channels

In practical cooperative MIMO systems, the channels between antennas pairs are spatially correlated due to the close proximity of the antennas at the transmitting and receiving nodes. Therefore, it is important to assess the impact of the correlated channels on performance.

Generation of correlated channels in this paper is performed using the intelligent multielement transmit and receive antenna model in combination with a power azimuth spectrum (PAS) model [34], [38]. Spatial correlation matrices are generated for each antenna array of the base station ( $\mathbf{R}_{BS}$ ) and mobile station ( $\mathbf{R}_{MS}$ ), and the overall correlation matrices for the uplink and downlinks are, respectively, given by

$$\begin{aligned} \mathbf{R}_{UP} &= \mathbf{R}_{MS} \otimes \mathbf{R}_{BS} \\ \mathbf{R}_{DN} &= \mathbf{R}_{BS} \otimes \mathbf{R}_{MS} \end{aligned} \quad (60)$$

where  $\otimes$  represents the Kronecker product. We apply the proposed schemes to a macrocell environment where the PAS is given by a truncated Laplacian distribution with angle spread (AS) =  $5^\circ$  and AS =  $10^\circ$  for the mobile station and base station, respectively. A single arrival cluster is assumed for all nodes, and the angles of arrival for the mobile and base station are given by  $67.5^\circ$  and  $20^\circ$ , respectively. The antenna spacing at all nodes is  $0.5\lambda$ , where  $\lambda$  denotes the system wavelength.

## IX. CONCLUSION

We have presented TDS and RS methods based on DSA for multirelay cooperative MIMO systems, where RS improves the performance of conventional TDS. Hybrid continuous-discrete MMSE and MI optimization problems have been formed, and a framework to solve them has been developed. The resulting joint TDS with RS DSA schemes have been shown to operate well with optimal receivers, converge in parallel with low-complexity linear adaptive MMSE receivers, exceed the performance of GAS, and, in the majority of scenarios, converge to the optimal solution. Increased diversity and improved interference suppression have been shown to be obtained by the proposed schemes, and full algorithmic implementations have then been given to provide designers with the tools to significantly improve the performance of cooperative MIMO systems.

## REFERENCES

- [1] A. Scaglione, D. L. Goeckel, and J. N. Laneman, "Cooperative communications in mobile ad hoc networks," *IEEE Signal Process. Mag.*, vol. 23, no. 5, pp. 18–29, Sep. 2006.
- [2] Y. Fan and J. Thompson, "MIMO configurations for relay channels: Theory and practice," *IEEE Trans. Wireless Commun.*, vol. 6, no. 5, pp. 1774–1786, May 2007.
- [3] S. W. Peters, A. Y. Panah, K. T. Truong, and R. W. Heath, "Relay architectures for 3GPP LTE-advanced," *EURASIP J. Wireless Commun. Netw.*, vol. 2009, p. 618 787, 2009.
- [4] Z. Fang, Y. Hua, and J. C. Koshy, "Joint source and relay optimization for a non-regenerative MIMO relay," in *Proc. 4th IEEE Workshop Sens. Array Multichannel Process.*, Waltham, MA, Jul. 2006, pp. 239–243.

- [5] I. Berenguer, X. Wang, and V. Krishnamurthy, "Adaptive MIMO antenna selection via discrete stochastic optimization," *IEEE Trans. Signal Process.*, vol. 53, no. 11, pp. 4315–4329, Nov. 2005.
- [6] J. N. Laneman, D. N. C. Tse, and G. Wornell, "Cooperative diversity in wireless networks: Efficient protocols and outage behaviour," *IEEE Trans. Inf. Theory*, vol. 50, no. 12, pp. 3062–3080, Dec. 2004.
- [7] A. Nosratinia, T. E. Hunter, and A. Hedayat, "Cooperative communications in wireless networks," *IEEE Commun. Mag.*, vol. 42, no. 10, pp. 74–80, Oct. 2004.
- [8] V. Stankovic, A. Host-Madsen, and Z. Xiong, "Cooperative communications in wireless networks," *IEEE Signal Process. Mag.*, vol. 23, no. 5, pp. 37–49, Sep. 2006.
- [9] M. A. Torabi and J. Frigon, "Semi-orthogonal relay selection and beamforming for amplify-and-forward MIMO relay channels," in *Proc. IEEE Wireless Commun. Netw. Conf.*, Las Vegas, NV, Mar. 2008, pp. 48–53.
- [10] S. W. Peters and R. Heath, "Nonregenerative MIMO relaying with optimal transmit antenna selection," *IEEE Signal Process. Lett.*, vol. 15, pp. 421–424, 2008.
- [11] G. J. Foschini, "Layered space-time architecture for wireless communication in a fading environment when using multiple antennas," *Bell Labs. Tech. J.*, vol. 1, no. 2, pp. 41–59, Autumn 1996.
- [12] H. Zhang, H. Dai, and B. L. Hughes, "Analysis on the diversity-multiplexing tradeoff for ordered MIMO SIC receivers," *IEEE Trans. Commun.*, vol. 57, no. 1, pp. 125–133, Jan. 2009.
- [13] R. Fa and R. C. de Lamare, "Multi-branch successive interference cancellation for MIMO spatial multiplexing systems: Design, analysis and adaptive implementation," *IET Commun.*, vol. 5, no. 4, pp. 484–494, May 2011.
- [14] P. Li, R. C. de Lamare, and R. Fa, "Multiple feedback successive interference cancellation detection for multiuser MIMO systems," *IEEE Trans. Wireless Commun.*, vol. 10, no. 8, pp. 2434–2439, Aug. 2011.
- [15] R. C. de Lamare and R. Sampaio-Neto, "Minimum mean squared error iterative successive parallel arbitrated decision feedback detectors for DS-CDMA systems," *IEEE Trans. Commun.*, vol. 56, no. 5, pp. 778–789, May 2008.
- [16] R. C. de Lamare, R. Sampaio-Neto, and A. Hjrungnes, "Joint iterative interference cancellation and parameter estimation for CDMA systems," *IEEE Commun. Lett.*, vol. 11, no. 12, pp. 916–918, Dec. 2007.
- [17] Y. Cai and R. C. de Lamare, "Adaptive space-time decision feedback detectors with multiple feedback cancellation," *IEEE Trans. Veh. Technol.*, vol. 58, no. 8, pp. 4129–4140, Oct. 2009.
- [18] Y. Cai, D. le Ruyet, and D. Roviras, "Joint interference suppression and power allocation techniques for multiuser multiantenna relay broadcast systems," in *Proc. Int. Symp. Wireless Commun. Syst.*, York, U.K., Sep. 2010, pp. 265–269.
- [19] R. C. de Lamare, "Joint iterative power allocation and interference suppression algorithms for cooperative spread spectrum networks," in *Proc. Int. Conf. Acoust., Speech Signal Process.*, Dallas, TX, Mar. 2010, pp. 3178–3181.
- [20] R. C. de Lamare and R. Sampaio-Neto, "Adaptive interference suppression for CDMA based on Interpolated FIR filters in multipath channels," *IEEE Trans. Veh. Technol.*, vol. 56, no. 5, pp. 2457–2474, Sep. 2007.
- [21] R. C. de Lamare and R. Diniz, "Set-membership adaptive algorithms based on time-varying error bounds for CDMA interference suppression," *IEEE Trans. Veh. Technol.*, vol. 58, no. 2, pp. 644–654, Feb. 2009.
- [22] M. Ding, S. Liu, H. Luo, and W. Chen, "MMSE based greedy antenna selection scheme for AF MIMO relay systems," *IEEE Signal Process. Lett.*, vol. 17, no. 5, pp. 433–436, May 2010.
- [23] I. Bahceci, T. M. Duman, and Y. Altunbasak, "Antenna selection for multiple-antenna transmission systems: Performance analysis and code construction," *IEEE Trans. Inf. Theory*, vol. 49, no. 10, pp. 2669–2681, Oct. 2003.
- [24] S. Chen, W. Wang, X. Zhang, and D. Zhao, "Performance of amplify-and-forward MIMO relay channels with transmit antenna selection and maximal-ratio combining," in *Proc. IEEE Wireless Commun. Netw. Conf.*, Budapest, Hungary, Apr. 2009, pp. 1–6.
- [25] B. C. Lim, W. A. Krzymien, and C. Schlegel, "Efficient sum rate maximization and resource allocation in block-diagonalized space-division multiplexing," *IEEE Trans. Veh. Technol.*, vol. 58, no. 1, pp. 478–484, Jan. 2009.
- [26] F.-S. Tseng and W.-R. Wu, "MMSE-SIC transceiver design in amplify-and-forward MIMO relay systems," in *Proc. IEEE Veh. Technol. Conf.*, Taipei, Taiwan, May 2010, pp. 1–5.
- [27] H. S. Ryu, C. G. Kang, and D. S. Kwon, "Transmission protocol for cooperative MIMO with full rate: Design and analysis," in *Proc. IEEE Veh. Technol. Conf.*, Dublin, Ireland, May 2007, pp. 934–938.
- [28] P. Clarke and R. C. de Lamare, "MMSE transmit diversity selection for multi-relay cooperative MIMO systems using discrete stochastic gradient algorithms," in *Proc. IEEE 17th Int. Conf. Digit. Signal Process.*, Corfu, Greece, Jul. 2011, pp. 1–6.
- [29] P. Clarke and R. C. de Lamare, "Joint transmit diversity optimization and relay selection for multi-relay cooperative MIMO systems using discrete stochastic algorithms," *IEEE Commun. Lett.*, vol. 15, no. 10, pp. 1035–1037, Oct. 2011.
- [30] S. Andrados, "A global search method for discrete stochastic optimization," *SIAM J. Opt.*, vol. 6, no. 2, pp. 513–530, May 1996.
- [31] L. Zheng and D. N. C. Tse, "Diversity and multiplexing: A fundamental tradeoff in multiple-antenna channels," *IEEE Trans. Inf. Theory*, vol. 49, no. 5, pp. 1073–1096, May 2003.
- [32] A. Hedayat and A. Nosratinia, "Outage and diversity of linear receivers in flat fading MIMO channels," *IEEE Trans. Signal Process.*, vol. 55, no. 12, pp. 5868–5873, Dec. 2007.
- [33] S. Haykin, *Adaptive Filter Theory*, 4th ed. Englewood Cliffs, NJ: Prentice-Hall, 2002.
- [34] Y. S. Cho, J. Kim, W. Y. Yang, and C. G. Kang, *MIMO-OFDM Wireless Communications With MATLAB*. Hoboken, NJ: Wiley, Oct. 2010.
- [35] I. Telatar, "Capacity of multi-antenna Gaussian channels," *Eur. Trans. Telecommun.*, vol. 10, no. 6, pp. 585–595, Nov. 1999.
- [36] P. Lioliou, M. Viberg, and M. Coldrey, "Performance analysis of relay channel estimation," in *Proc. IEEE Asilomar Conf. Signals, Syst. Comput.*, Nov. 2009, pp. 1533–1537.
- [37] P. Lioliou and M. Viberg, "Least-squares based channel estimation for MIMO relays," in *Proc. Int. Workshop Smart Antennas*, Darmstadt, Germany, Feb. 2008, pp. 90–95.
- [38] L. Schumacher, K. I. Pedersen, and P. Mogensen, "From antenna spacings to theoretical capacities—Guidelines for simulating MIMO systems," in *Proc. IEEE Int. Symp. Pers., Indoor Mobile Radio Commun.*, Lisbon, Portugal, Sep. 2002, pp. 587–592.
- [39] R. C. de Lamare and R. Sampaio-Neto, "Adaptive reduced-rank MMSE filtering with interpolated FIR filters and adaptive interpolators," *IEEE Signal Process. Lett.*, vol. 12, no. 3, pp. 177–180, Mar. 2005.
- [40] M. L. Honig and J. S. Goldstein, "Adaptive reduced-rank interference suppression based on the multistage Wiener filter," *IEEE Trans. Commun.*, vol. 50, no. 6, pp. 986–994, Jun. 2002.
- [41] R. C. de Lamare and R. Sampaio-Neto, "Reduced-rank adaptive filtering based on joint iterative optimization of adaptive filters," *IEEE Signal Process. Lett.*, vol. 14, no. 12, pp. 980–983, Dec. 2007.
- [42] H. Qian and S. N. Batalama, "Data record-based criteria for the selection of an auxiliary vector estimator of the MMSE/MVDR filter," *IEEE Trans. Commun.*, vol. 51, no. 10, pp. 1700–1708, Oct. 2003.
- [43] R. C. de Lamare and R. Sampaio-Neto, "Reduced-rank space-time adaptive interference suppression with joint iterative least squares algorithms for spread-spectrum systems," *IEEE Trans. Veh. Technol.*, vol. 59, no. 3, pp. 1217–1228, Mar. 2010.
- [44] R. C. de Lamare and R. Sampaio-Neto, "Adaptive reduced-rank equalization algorithms based on alternating optimization design techniques for MIMO systems," *IEEE Trans. Veh. Technol.*, vol. 60, no. 6, pp. 2482–2494, Jul. 2011.

**Patrick Clarke** (S'09) received the M.Eng. degree in electronic engineering from the University of York, York, U.K., where he is currently working toward the Ph.D. degree with the communications research group.

His research interests are adaptive signal processing and cooperative communications.

**Rodrigo C. de Lamare** (S'99–M'04–SM'10) received the Diploma degree in electronic engineering from the Federal University of Rio de Janeiro, Rio de Janeiro, Brazil, in 1998 and the M.Sc. and Ph.D. degrees in electrical engineering from the Pontifical Catholic University of Rio de Janeiro, in 2001 and 2004, respectively.

Since January 2006, he has been with the Communications Research Group, Department of Electronics, University of York, York, U.K., where he is currently a Lecturer in communications engineering. His research interests include communications and signal processing. He has published more than 200 papers in refereed journals and conferences in these areas.

Dr. de Lamare served as the General Chair of the Seventh IEEE International Symposium on Wireless Communications Systems, which was held in York, in September 2010. He serves as Associate Editor for the *EURASIP Journal on Wireless Communications and Networking*.